



Debonair Marketing

PRODUCT CATALOGUE

COMPLETE JANITORIAL SUPPLY



YOUR ONE STOP CENTER

CONTENTS



01
Cleaning Machinery
Page 2 - 8



08
Cleaning Equipment
Page 62 - 67



02
Cleaning Chemical
Page 9 - 16



09
Household Detergent & Freshener
Page 68 - 70



03
Tissue Paper Towel
Page 17 - 23



10
Personal Safety Equipment
Page 71 - 80



04
Washroom Higeine Products
Page 24 - 29

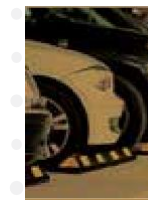

11
Road & Traffic Safety
Page 81 - 86



05
Waste Bin
Page 30 - 50

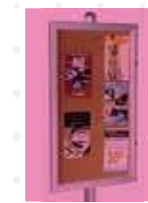

12
Display & Notice Board
Page 87 - 88



06
Trolley & Mopping Equipment
Page 51 - 57



13
Insect Trapper/ Fogger & Air Purifier
Page 89 - 90



07
Floor Matting
Page 58 - 61



14
Landscaping Machinese & Others
Page 91 - 92

01

To Reduce The Burden Of Cleanliness



Brand:



Floor Machine



<p>P1</p>  <p>Welco C154 Scrubber</p> <p>Power : 1200 watt Voltage : 230 volt Speed : 154 rpm Pad Size : 16" Weight : 39 kgs Dim. : 1200 x 542 x 425 mm</p>	<p>P2</p>  <p>Welco C175 Scrubber</p> <p>Power : 1500 watt Voltage : 230 volt Speed : 175 rpm Pad Size : 16" Weight : 40 kgs Dim. : 1200 x 542 x 425 mm</p>	<p>P3</p>  <p>Welco Karva 2.5HP Stone Refurbish Machines</p> <p>Power : 2.5 HorsePower Voltage : 220 volt Speed : 175 rpm Pad Size : 17" Weight : 52 kgs Cable Length : 13 meter</p>
<p>P4</p>  <p>Viper C1500 High Speed Polisher</p> <p>Power : 1500 watt Voltage : 220 volt Speed : 1500 rpm Pad Size : 37" Dim. : 1200 x 542 x 425 mm</p>	<p>P5</p>  <p>Welco SC1500 High Speed Polisher</p> <p>Power : 220 - 240 volt Voltage : 1500 rpm Speed : 175 rpm Pad Size : 37" Cable Length : 12 meter</p>	<p>P6</p>  <p>Welco Karva 2HP Stone Refurbish Machines</p> <p>Power : 2 Horse Power Voltage : 220 volt Speed : 175 rpm Pad Size : 17" Weight : 55 kgs Cable Length : 13 meter</p>



Carpet Extrator

<p>P7</p>  <p>Viper SC 38</p> <p>Voltage : 230 volt - 240 volt Brush Motor : 50 Hz Pump : 92 watt Solution Tank : 100 psi Recovery Tank : 38 lit Weight : 26.5 lit Weight : 40 kg</p>	<p>P8</p>  <p>Welco SC58H</p> <p>Clean Water Tank : 30 L Dirty Water Tank : 28 L Voltage : 220-240V Roll Brush Width : 400mm Length of Cable : 12m Roll Brush Diameter : 90mm Weight : 48 kg Water Sucking Motor : 220-240V / 1000w Rolling Brush Motor : 24VDC / 180w Heater : 2000 W</p>	<p>P9</p>  <p>Welco Genie 700 Carpet Extrator</p> <p>Solution Tank : 20 lit Recovery Tank : 70 lit Voltage : 220 - 240 volt Pump : 36 w 70 psi Power : 2 x 1000 watt Weight : 33kgs Sound Level : 80db</p>	<p>P10</p>  <p>welco Genie 400</p> <p>Power : 1000w Air Flow Rate : 106L/S Voltage : 220-240V Height : 890mm Length of Cable : 7m Pressure : 30psi Hose Diameter : 40mm Tank Diameter : 340mm Water Sucking Motor : 220VAC / 110W Weight : 17.5kg</p>
--------------------------------------------------------------------------------------------------------------------------------------------------------------------------------------------------------------------------------------------------------------------------------------------------------------------------------------------------------------------	----------------------------------------------------------------------------------------------------------------------------------------------------------------------------------------------------------------------------------------------------------------------------------------------------------------------------------------------------------------------------------------------------------------------------------------------------------------------------------------------------------------	------------------------------------------------------------------------------------------------------------------------------------------------------------------------------------------------------------------------------------------------------------------------------------------------------------------------------------------------------------------------------------------	-----------------------------------------------------------------------------------------------------------------------------------------------------------------------------------------------------------------------------------------------------------------------------------------------------------------------------------------------------------------------------------------------------------------------------------------------------------------------------

Wet & Dry Vacuum Cleaner



<p>P15</p>  <p>Welco WDV 7090</p> <p>Power : 2 x 1000 watt Voltage : 220 - 240 v Capacity : 70 lit Dry x 90 lit Wet Dimension : 900 mm HT x 440 Dia Cable : 7.2 meter Noise Level : 72 dB Weight : 19.7 kgs</p>	<p>P16</p>  <p>Welco WDV 702A</p> <p>Power : 2 x 1000 watt Voltage : 220 - 240 v Capacity : 70 lit Dry x 90 lit Wet Dimension : 850 mm HT x 440 Dia Cable : 7.2 meter Noise Level : 72 dB Weight : 18 kgs</p>	<p>P17</p>  <p>Welco WDV 2535A</p> <p>Power : 1 x 1000 watt Voltage : 220 - 240 v Capacity : 25 lit Dry / 35 lit Wet Dimension : 760 mm HT x 345 Dia Cable : 7.2 meter Noise Level : 71 dB Weight : 9.7 kgs</p>
------------------------------------------------------------------------------------------------------------------------------------------------------------------------------------------------------------------------------------------------------------------------------------------------------------------------------------------------------------------------------------------------	----------------------------------------------------------------------------------------------------------------------------------------------------------------------------------------------------------------------------------------------------------------------------------------------------------------------------------------------------------------------------------------------	------------------------------------------------------------------------------------------------------------------------------------------------------------------------------------------------------------------------------------------------------------------------------------------------------------------------------------------------------------------------------------------------

Auto Scrubber

<p>P11</p>  <p>Welco XD2A</p> <p>Width : 770mm Brush Dia. : 455mm Working Capacity : 1660m²H Solution Tank : 35 Lit Recovery Tank : 31 Lit Cable Length : 18m Weight : 75kg</p>	<p>P12</p>  <p>AS430C / AS510B</p> <p>Solution tank (liters) : 40/50 Recovery tank (liters) : 40/50 Brush/pad diameter (cm) : 43 / 51 Squeegee width (cm) : 73 / 79 Sound pressure level (dBA) : 70 / 70 Speed control (rpm) : 150 / 170 Brush motor (W) : 550 / 750 Cable length (meter) : 20 / 20 Battery type : - / 2x 12V 105Ah/20h AGM Net weight (kg) : 70 / 128 Size : 1200 (L)x 610 (W)x 1170 (H)mm</p>	<p>P13</p>  <p>Viper AS 701 R</p> <p>Working Width : 940 mm Squeegee Width : 750 Solution Tank : 120 lit Recovery Tank : 120 lit Battery : 4 x 6 volt Weight : 245 Ah AGW Working Capacity : 4410 sq m/hrs</p>	<p>P14</p>  <p>Comac Innova 55B</p> <p>Squeegee Wight : 705-800mm Disc Brush ø (No.) : 560mm Motor : 24V / 450W Brushes rpm : 170rpm Motor : 24V / 310W Traction Motor : 24V / 300W Suction Vacuum : 70mbar Forward Speed : 0+5.5 km/h Batteries (GEL) (n.) : 12V/134 (2)Ah</p>
---------------------------------------------------------------------------------------------------------------------------------------------------------------------------------------------------------------------------------------------------------------------------------------------------------------------------------------------------------------------------	----------------------------------------------------------------------------------------------------------------------------------------------------------------------------------------------------------------------------------------------------------------------------------------------------------------------------------------------------------------------------------------------------------------------------------------------------------------------------------------------------------------------------------------------------------------------------------------------------------------------------------------------------	------------------------------------------------------------------------------------------------------------------------------------------------------------------------------------------------------------------------------------------------------------------------------------------------------------------------------------------------------------------------------------------------	--------------------------------------------------------------------------------------------------------------------------------------------------------------------------------------------------------------------------------------------------------------------------------------------------------------------------------------------------------------------------------------------------------------------------------------------------------------------------------------------

<p>P18</p>  <p>Karcher MV5 Premium Multi Purpose Wet & Dry Vacuum Cleaner (Blower Function)</p> <p>Power : 1800 watt Capacity : 25 lit Dimension : 5 meter Cable : 5 meter Noise Level : 71 dB Weight :</p>	<p>P19</p>  <p>Welco WDV 2535</p> <p>Power : 1 x 1000 watt Voltage : 220 - 240 v Capacity : 25 lit Dry x 35 lit Wet Dimension : 760 mm HT x 345 Dia Cable : 7.2 meter Noise Level : 71 dB Weight : 9.7 kgs</p>	<p>P20</p>  <p>Nilfisk Alto 50-01PC</p> <p>Power : 1200 watt (max) Capacity : 47 lit / 47 lit Dimension : 450 X 380 X 750 (mm) Noise Level : 59 dB Voltage : 230v</p>
-------------------------------------------------------------------------------------------------------------------------------------------------------------------------------------------------------------------------------------------------------------------------------------------------------------------------------------------------------------------------------------	-------------------------------------------------------------------------------------------------------------------------------------------------------------------------------------------------------------------------------------------------------------------------------------------------------------------------------------------------------------------------------------------------	------------------------------------------------------------------------------------------------------------------------------------------------------------------------------------------------------------------------------------------------------------------------------------------------------------------------------



Dry Vacuum Cleaner

P21



Nilfisk GD930
 Motor : 1000 watt
 Amperage : 8.7amps
 Weight : 7.5kg
 Size : 15" x 17.5" x 13" 4f
 Noise Level : 53dB

P22



Welco Windly DV 10
 Motor : 1000 watt
 Voltage : 220 - 240
 Weight : 11 kgs
 Size : 400 x 480 mm
 Cable Length : 15 meter
 Capacity : 10 lits

P23



Soteco CRV 15 Clean Room Vacuum (Hospital Grade)
 Motor : 1000 watt
 Voltage : 220 - 240
 Weight : 8.7 kg
 Noise Level : 64 db
 Size : 400 x 480 mm
 Filtration : 4 stage, 0.3 micron
 (2 Hepa Fillers, 1 Polyester Filter & 1 Paper Bag)

P24



Welco DVS 10
 Motor : 1000 watt
 Voltage : 220 - 240v
 Weight : 8.7 kg
 Capacity : 10 liter
 Size : 345 Dia. x 320mm lff
 Weight : 9.3kg

P25



Welco BP 5 Back Pack Vacuum
 Motor : 1000 watt
 Voltage : 220 - 240 v
 Weight : ± 5 kgs
 Size : 360 x 550 H/mm
 Cable Length : 15 m
 Capacity : 5lits

P26



Welco DV 15
 Motor : 1000 watt
 Voltage : 230 - 240 v
 Capacity : 15 m
 Cable : 7 m
 Dimension : 345 Dia x 550 H/mm
 Weight : 9.6kgs

P27



Comac Piccolo
 Motor : 1000 watt
 Capacity : 13 lit
 Cable : 10 m
 Weight : 7 kgs
 Noise Level : 60dB

P28



Eco Baby
 Motor : 900 watt
 Capacity : 10 lit
 Weight : 3.7 kg
 Size : 330 x 320 x 310 (mm)
 Cable Length : 8 m



Sweeper

P29



Welco MS 800 Manual Floor Sweeper
 Capacity : 34 lit
 Working Capacity : 2500 sq feet / hour
 Operating Width : 800 mm
 Dimension : 130 x 84 x 103 mm
 Weight : 16 kg

P30



ECM 450 Escalator Cleaner
 Power : 1180W
 Operating Width : 450 mm
 Dry Motor : 220VAC / 1000W
 Roll Brush Motor : 24VDC / 120W
 Capacity : 20 Ltr
 Cable : 12 M
 Weight : 34 Kg
 Size : 95X54X31 CM

High Pressure Cleaner

P31



Welco IP 150 (Inter Pump) Petrol Operated
 Honda Engine : 5.0 HP
 Flow Capacity : 150 Bar
 Weight : 38 kg
 Flow Capacity : 12 lit / minute

P32



Portotecnica Elite 1630M / 1930M
 Pressure : 110 bar
 130 bar
 Flow Capacity : 12 lit/minute
 10 lit/minute

P33



Densin C110E / C170E
 Pressure : 110 bar
 170 bar
 Flow Capacity : 11.7 lit/minute
 15.2 lit/minute

P34



Jet Master Bravo 1013K
 Pressure : 130 bar
 Flow Capacity : 10.5 lit/minute
 Power : 2,900 Watt
 Hose Length : 10 Meter

Wind Blower

P35



Welco BF 750
 Power : 750 watt
 Voltage : 220 - 240 v
 Body : Roto Cast Poly Ethylene
 Dimension : 440 x 500 x 510 mm
 Rotation Rate : 3 speed
 Weight : 15 kgs

P36



Welco BFT 900
 Power : 900 watt
 Voltage : 220 - 240 v
 Rotation Rate : 3 speed
 Air Flow : 110 m³ / minute
 Cable : 7 meter
 Noise Level : 66 dB
 Weight : 16.6 kgs
 (Adjustable Handle With Wheel)

P37



Power Jet 3250 High Pressure Cleaner
 Rated Voltage : AC220-240V
 50Hz
 Rated Input Power : 2500W
 Protection Class : I
 Degree of Protection : IPX5
 Design : Germany
 Rated Pressure : 130bar
 Max. Pressure : 170bar
 Max. Flow : 8.0 l/min
 Rated Temperature : 0-40 Celsius
 Max. Inlet Pressure : 0.7Mpa
 Sound Pressure Level : 77dB
 Sound Power Level : 96dB
 Vibration Value : 1.8 m/s³
 Weight : 24.5kg



Accessories For Cleaning Machine

02

Clean Is Not Enough

P38

Dry Vacuum Accessories (32mm)

1. Metal Tube
2. Round Brush
3. Dry Nozzle
4. Wet Nozzle (optional)
5. Sofa Nozzle
6. Crevice Tool
7. Suction Hose
8. Swivel Connector (Short connector)
9. Elbow Joint (Long Connector)

Compatible With Dry Vacuum Model:
DV10 , CRV10 , DVS10 , BP5 & DV15

Wet & Dry Vacuum Accessories (38 mm)

1. Metal Tube
2. Round Brush
3. Dry Nozzle
4. Wet Nozzle
5. Crevice Tool
6. Suction Hose
7. End Cuff (To Metal Tube)
8. Swivel Connector (To Vacuum Body)

Compatible With Wet & Dry Vacuum Model:
WDV7090 , WDV702A , WDV 2535 & WDV2535A



Accessories For Cleaning Machine

<p>P39</p> <p>Trangential Motor (Extractor Motor) 2 Stage /3 Stage Power 1000 W</p>	<p>P40</p> <p>Dry Vacuum Motor 1 Stage /2 Stage Power 1000 W</p>	<p>P41</p> <p>Wet & Dry Vacuum Motor 1 Stage /2 Stage Power 1000 W</p>	<p>P42</p> <p>Double Layer Wet Pick Up Rubber Replacement</p>	<p>P43</p> <p>Single Layer Wet Pick Up Rubber Replacement</p>
<p>P44</p> <p>Solution Tank</p>	<p>P45</p> <p>Cloth Filter (Dry Vacuum)</p>	<p>P46</p> <p>Dry Vacuum Cloth Dust Bag (Reuseable)</p>	<p>P47</p> <p>Dry Vacuum Paper Dust Bag (Disposable)</p>	<p>P48</p> <p>3M Floor Pad 16" /18" /20" Red - Buffing White - Polishing Black - Stripping (Deep Cleaning) Blue - Scrubbing (Light Cleaning) Purple - Crystalization</p>
<p>P49</p> <p>16" Hard Floor Scrubbing Brush (For C154 , C175 & Numatic Scrubber)</p>	<p>P50</p> <p>16" Pad Holder (For C154 , C175 & Numatic Scrubber)</p>	<p>P51</p> <p>16" Bonet Pad (For Carpet Cleaning)</p>	<p>P52</p> <p>16" Carpet Shampoo Brush (For C154 , C175 & Numatic Scrubber)</p>	<p>P53</p> <p>16" Sanding Screen (For Parquet)</p>

Associate Brand:



Floor Care



EMMA 804 Polyshine (High Gloss Floor Finish)

High gloss, metalized emulsion, self-shinning polish for vinyl, rubber, linoleum and sealed floors. Contain 20% polymer for long lasting deep slip resistant shine. Two or three thin coats are recommended for the best results. White emulsion with acrylic odor. Coverage approximately 250m² per 1 US gal. per coat. Ready to use.

EMMA 805 Super Top Glass (Wet Look Floor Finish With Sealer)

A 25% solids, extra durable acrylic polish, which dries glossy and burnishes to a 'wet look' finish. Two or three thin coats are recommended for the best results. White emulsion with acrylic odor. Coverage approximately 250m² per 1 US gal. per coat. Ready to use.



EMMA 890 C1 Powder (Crystallization Powder for Marble and Terrazzo)

A special formulated compound used to maintain marble & terrazzo. It chemically transforms the stone surface similar to the methodology done at the factory. Coverage approximately 500sq feet per kilo.

EMMA 890 C2 Gel (Granite & Glaze Tiles) Crystallization Liquid

A special gel for the restoration and maintenance of all type of granite and glazed tile. To be used with a stone polishing machine and a steel wool pad.



EMMA 806 Apex Seal (Undercoat Floor Sealer)

A water base acrylic seal for vinyl, rubber, asphalt, terrazzo, linoleum and semi porous floor surfaces. Provide base coat seal with satin finish which can top coated with Polyshine if required. White emulsion with acrylic odor, coverage approximately 150m² per gal. per coat. Ready to use. pH 7.2.

EMMA 807 Creat Seal (All Weather Floor Sealer)

Create a durable and glossy finish on most floor surfaces. It is water resistant and absolutely skid-proof. New technologies solvent base fluorocarbon oil and water repellent penetrative seal for terracotta, sand stone, concrete, grout, brick and other porous floor surfaces. Does not change the appearance of natural stone. Apply by sprayer, roller, brush or mop. Clear liquid with mild acrylic odor. Ready to use.



EMMA 809 Buff-Up

A blend of polymer and surfactant to provide a glossy and tough protective coating for polish floor which will reduce stripping cycle.

EMMA 809 Micro-Buff (Shine Maintainer)

A spirit based silicone intensifier that impregnate into the surface of the stone and forms an invisible film within the pores and capillaries. Helps protect from water base staining and general dirt. For use on all polished and unpolished natural and artificial stone.

Washroom Sanitizer & Deodorizer



EMMA 819 Disinfectant Deodorizer

(Jen Fresh, Flora Fresh, Drakka Fresh, Strawberry, Jasmine, Happy Fresh, Lavender Fresh) These fragrances are emulsified in a rich surfactant and a quaternary QAP 80 to give a clean odor free environment. Ideal for use toilet, office, confined areas and only place where hygiene has precedence.



EMMA 854 Bathroom Cleaner

A fast acting detergent that design for toilets, urinals porcelain, ceramic stainless steel that removes algae, mould, mildew, soap scum and body fat.



EMMA 828 Power Pine Gel

Excellent disinfectant water soluble gel with a fresh pine fragrance to clean sanitize and deodorize toilet and washroom area.

EMMA 827 Liquid Pine

Extract from pine tree with quaternary compound provide higher grade disinfectant with a fresh pine fragrance to eliminate residual odors and improved disinfecting qualities. Suitable for washroom and public toilet.



EMMA 820 DEO Block (Packing 20kg, 5kg)

Deoblock is employed in most washroom specially in the urinal bowl and WC bowl. The strong deodorizing power of Deoblock will eliminate offensive malodor that persists in washroom.

Hand & Body Care



EMMA 825 Hand Soap

This gentle hand cleanser works effectively, make the skin elastic and leaves a nice delicate fragrance.

EMMA 825AB Hand Soap Antibacteria

Disinfection liquid hand soap for washing hand. Excellent bactericidal and fungicidal properties. Gentle for hand, does not cause skin desiccation and irritation. The products ingredient is microbiologically and dermatological tested.

EMMA 826 Hair And Body Shampoo

A mild hair and body shampoo for use in liquid dispenser will not harm even the fairest hair or skin. Its rich lather rinses away freely and leaves skin feeling smooth and clean with pleasant scent.

Hand & Body Care

P63



EMMA 833 Waterless Hand Gel

Effective heavy duty waterless hand cleaner. Removes stains caused by grease, fuel, hydraulic oil, industrial fluids and carbon black. The addition of moisturizing agent and the soft abrasive allows the softly remove stains without drying out the stain.

EMMA 861 Sani Gel / Liquid

Ready to use. It is a hygiene hand sanitizer & cleaner without use of water. 99.9% effective against most common illness germs that are transmitted by hands.

EMMA 882 Foam Soap Liquid

Specially designed foaming formulas enriched with moisturizer. Provide an amazing gentle cleansing experience along with fresh scent.

Stewarding Care

P66



EMMA 864 Super Wash

Highly alkaline, low foaming liquid for machine washing of dishes in gastronomy dishwashing machines. Effectively remove food stains of acid origin, of whitening properties due to active chlorine. Prevent the dishes to turn yellow. Recommended for use in canteens, bars and restaurants.

EMMA 870 Rinse Aid

It is mild detergent design to allow dishes and glasses to dry evenly without streaking. Vegan and easy to use. It leaves no taste on your dishes. No phosphates are used, preserving rivers, lakes and streams. All ingredients are fully biodegradable and no harmful chemicals are left behind.

EMMA 848 D Wash

A mild perfume concentrated hand dish washing detergent with excellent grease cutting properties.

EMMA 815A Beer Glass Cleaner

Concentrated formula specially design for glass washing which effectively remove lipstick, grease and protein matter. without leaving residues aftertaste and odor.

P67



EMMA 832 Enzymes Cleaner

Contain a special blend of concentrated non-toxic natural microbial that effectively digest oils, fats, grease and other organic matter blocking or impeding drainage system or grease traps. Is environment friendly products.

EMMA 875 Oven Cleaner

Ready to use, cleaning ovens, barbecues, grills, fireplace, including fireplaces with panes. Effectively removes burnt and smoky contamination.

EMMA 888 Stain Away Food Grade Kitchen Equipment Cleaner

Highly foaming preparation for through cleaning and degreasing of machine equipment and all other in gastronomy and food industry. Surface in direct contact with food stuff production, preparation and transportation.

Carpet & Car Care

P64



EMMA 822A Low Foam Carpet Shampoo

Concentrate professional carpet extraction cleaning detergent. Suitable for most of the carpets and rugs. Also incorporated prime technology to help prevent residues that may attract soil. Clear liquid with drakka fragrance. Dilution 1 to 10. pH ± 12 .

EMMA 857 Carpet Spotters

Heavy duty alkaline base protein spotter for blood, vomit, wine, fresh tea, coffee and most food based stains. Clear liquid with mint fragrance. Dilution 1 to 2 ready to use. pH ± 13 .

EMMA 824 Antiform

Concentrate antiform agent for extraction machine recovery tanks. Contain powerful silicone emulsion which counteracts foam from previous shampoo residue. White liquid with mild odor. Dilution 1 to 500 or as required.

P65



EMMA 830 Car Shampoo

Concentrated vehicle detergent to remove grease & dirt from vehicle with no damage to paint work.

EMMA 830A Snow Wash Car Shampoo

Concentrate, foaming shampoo special formulated for foam make nozzle (snow wash) or portal and brush car washing. Create very dense, stable foam that removes dirt, dust and other traffic contamination very well.

EMMA 836 Solve Kleen

A concentrate heavy duty alkaline cleaner. Excellent for automotive decreasing for removal of heavy deposits of oil grease road grime.

EMMA 837 Tyre Bright

A ready to use which apply to sponge or spray on to clean and rejuvenates tyre bumper to give extra shine.

Hard Surface Care

P68



EMMA 801 E Strip (Heavy Duty Wax Stripper)

Ammonia free floor polish stripper and cleanser for remover of old metalized emulsion polish. Can be applied with mop or rotary scrubbing machine. Dilution 1 to 4, pH ± 13 .

EMMA 801A Quick Strip (Powerful Fast Action Stripper)

Non-ammoniated high power wax stripper to efficiency remove time hardened finishes and heavy built-up edges.

P69



EMMA 810A Hi Kleen

This super alkaline cleaner was develop to wipe out & emulsify grease, stain soil from all hard smooth surface. Clean liquid with mild odor. Dilution 1 to 50.

EMMA 810B Kleen Jen

Alkaline bactericidal detergent with deodorizer for use on floors and washable surface. Active ingredient compliance by FDA, Dilution 1 to 50. pH ± 13 .

EMMA 811 Multi Purpose Cleaner

Concentrated general purpose high foaming neutral pH. Suitable for use on floor, walls and hard surfaces. Blue liquid with lemon and bouquet fragrance. Dilution 1 to 100. pH ± 7 .

Hard Surface Care

P70



EMMA 813 Auto Kleen

Low foaming concentrated alkaline cleaner. Specially formulated to use in Auto Scrubber Machine. It leaves floors sparkling clean without leaving film or streaks and reduce excessive rinsing.

EMMA 814 IND Kleen

High foaming preparation with decreasing and cleaning properties for daily and intensive cleaning of floors. Perfectly dissolves old oil and fat impurities (both animal vegetable and petroleum). Preferred for all types of hard surface in the kitchen, catering and industrial surface in heavy industry.

EMMA 815 Glass Kleen

Ready to use. Effectively removes hand prints, fat stains, natural dirt and dusts. Recommended for use on windshields TV and computer monitor screen.

P71



EMMA 816 Cement Softener

Highly acid for removal of large amount of rust, water scale, cement bulges from surfaces resistant to acid. Do not apply onto enamel surface. Do not allow the drying of the covered with working solution.

EMMA 817 S-Out (Toilet Bowl Cleaner)

It is a fast action toilet bowl and urinal cleaner with disinfectant agent to remove uric acid, rust stain and water marks instantly. Do not apply on enamel surface.

EMMA 818 Deep Double (Mosaic Cleaner)

A heavy duty descaler which effectively remove encrusted lime scale deposite on ceramic surface, WC and shower cubicle. Not suitable on stainless steel or chrome. Wet the surface before use. Dilution 1 to 5. pH±1.

P72



EMMA 821 Gum Remover

This products is ready to use and safe on carpets and upholsteries but be sure to test spot on a hidden area. Spray on gum, allow 5 minutes wet times. Scrup of scrape of using brush or putty knife. On stubborn stains, may require 2-3 applications.

EMMA 829 Stainless Steel Polish

Ready to use. Remove the dirt from steel quickly and form a thin inactivation film on the steel surface, which can prevent penetration of contaminations and make the stainless steel clean and shining. Direction: spray the some of this product on the surface and wipe it with soft cloth.

EMMA 838 Coil Kleen

Penetrating and emulsifying atmospheric soil on chiller coil to restore cooling efficiency. Non-flammable and non acidic. It can also be used as filter cleaner. Works by condensation. No manual scrubbing is required.

P73



EMMA 839 Scouring Cream

An effective non scratch cream suitable for cleaning of basins, stainless steel sink, ceramic cooker pot.

EMMA 878 Alu Clean (Aluminium Composite Panel Cleaner)

Special formulated cleaner for quick & easy removal of soil and grease. This powerful cleaner penetrates and loosens build up stain. Recommended to use and external wall of high-rise building.

Speciality Product

P74



EMMA 843 Laundry Detergents

A concentrate liquid detergent design for most types of heavy soiling fabric. This product has excellent stain removal properties which greatly reduced the need for pre-wash and pre-soaking. Leaves laundered fabric with a lingering freshness. Use rate may be varying according to the type and amount of soiling. Recommended dosage: 15-20ml per kilo load.

EMMA 851 Fabrics Soft

Excellent fabric conditioner gives a soft luxurious fluffy feel to your clothes, making ironing easier and prolonging fabric life. Fresh clean aroma even after storage.

EMMA 853 Oxy Bleach

A concentrated solution of hydrogen peroxide oxidizing agent. Provide a high level of stain removal. May be used to remove bleachable stain which cannot be treated by chlorine based bleaches due to risk of color removal and fabric damage.

EMMA 853A Clorox Bleach

Effective chlorine bleaching agent for only all white clothing & linens.

P75



EMMA 849 Masaage Oil

An excellent muscle massage oil suitable for use on bruises, strains, general aches and after strenuous exercise. A wonderful way to treat your sore exhausted body and is best reserved for time of 'severe need'.

EMMA 849A Aromatic Massage Oil

Exotic aromatic and incredibly indulging. It was rated for general purpose use that can be applied for fun or therapy. Excellent for therapeutic massage and as a fine body oil.

P76



EMMA 858 Fly Repellent Spray

To create a relaxing fly free environment. Recommended to use in kennels, pet shop, veterinary practice, animal and avian housing. Ready to use indoor and outdoor.

EMMA 881 Sanitizing Liquid (For Hard Surface)

A ready to use for waching and disinfect generally the surfaces of equipment of each type in public area. Such as Bus, LRT, Train, Fitness Centre, Escalator's handle.

P77



EMMA 899 Urinal Sanitizer Refill

A concentrate sanitizing liquid with a refreshing strawberry fragrance. Keeps toilet healthy and prevents unpleasant odor. Dilution: 1 part of solution 3 part of filter water.

Speciality Product

03



Your Satisfactory, Our Priority.

P78



EMMA 811A Mop & Shine

To give a beautiful floor a fresh fragrance in quick convenient one step process. Not only clean away dirt, it leaves an invisible shield to protect your floor from scratches. It is safe to use on marble, granite, terrazzo, vinyl, tile, limoleum & no wax floor.

EMMA 838 Coil Kleen

Penetrating and emulsifying atmospheric soil on chiller coil to restore cooling effecency. Non-flammable and non-acidic. It can also be used as filter cleaner. Works by condensation. No manual scrubbing is required.

P79



EMMA 880 C.O.L. Powder (Algae Remover)

Institution formulation of chlorine powder with bleaching agent is to remove mildew and algae deposits. Mostly use on drain or cement flooring.

EMMA 889 Vomit Powder

Vomit absorbent germicidal and deodorizer powder. Suitable to use at any flooring. Recommended to use on carpet.

P80



EMMA 862 Sanibin Fluids (Sanitary Bin Sanitizing Liquid)

Liquid form of germicidal detergent for use in sanitary bin. It use to kill bacteria and as disinfectant deodorizer. Recommended dosage: 10-20ml/bin.

EMMA 868 Sanibin Powder (Sanitary Bin Sanitizing Powder)

This powder form of germicidal detergent for use in sanitary bin. It use to kill bacteria and as disinfectant deodorizer. Recommended dosage: 15-20mg/bin.

P80A



Hi-CHLON 70 Swimming Pool Chlorine

Granular Hi-Chlon 70G- (45kg/Drum Calcium Hypochlorite)
White granular compound.
(Produced by the Nippon Soda Co., Ltd)



Brand:



Hand Towel Tissue



Inter (L) Fold Hand Towel



Code	Specification	Packing	Total Sheets
Inter Fold Pulp	210mm x 200mm x 1ply	200 sheet x 20 packs x 1ctn	4000 sheets
L Fold Pulp	200mm x 190mm x 1ply	200 sheet x 20 packs x 1ctn	4000 sheets
LFold Seal Pack Sugercane Pulp	225mm x 200mm x 1ply	250 sheets x 16 packs x 1ctn	4000 sheets



Multi (M) Fold Hand Towel



Code	Specification	Packing	Total Sheets
M Fold (Large) Pulp	210mm x 230mm x 1ply	200 sheets x 20 packs x 1ctn	4000 sheets
M Fold (Small)	210mm x 190mm x 1ply	200 sheets x 20 packs x 1ctn	4000 sheets
M Fold Medium (Eco Recycle L)	210mm x 230mm x 1ply	200 sheets x 20 packs x 1ctn	4000 sheets
M Fold Medium (Eco Recycle S)	210mm x 190mm x 1ply	200 sheets x 20 packs x 1ctn	4000 sheets



Center Flow (CFT) Hand Towel



Code	Specification	Packing	Total Sheets
CFT Normal Pulp	300 meter x 200mm x 1ply	6 rolls x 1ctn	3600 sheets
CFT Embossed Pulp	265 meter x 200mm x 1ply	6 rolls x 1ctn	3600 sheets



Hand Roll Towel (HRT) Hand Towel



Code	Specification	Packing	Total Sheets
HRT Pulp	150 meter perroll (1ply)	12 rolls x 1ctn	3520 sheets
HRT Recycle	1kg per roll (1ply)	12 rolls x 1ctn	3520 sheets



Hand Towel Tissue



Hygiene Bath Tissue (HBT)



Code	Specification	Packing	Total Sheets
HBT 1 Ply Emboss Pulp	100mm x 200mm x 1ply	250 sheets x 36 packs x 1ctn	9000 sheets
HBT 1 Ply Pulpall)	100mm x 200mm x 1ply	460 sheets x 36 packs x 1ctn	16560 sheets
HBT 1 Ply Recycle	100mm x 200mm x 1ply	460 sheets x 36 packs x 1ctn	16560 sheets
HBT 2 Ply Pulp	100mm x 200mm x 1ply	250 sheets x 36 packs x 1ctn	9000 sheet



Hand Roll Towel (HRT) Hand Towel



Code	Specification	Packing
HRT Pulp	150 meter perroll (1ply)	12 rolls x 1ctn
HRT Recycle	1kg per roll (1ply)	12 rolls x 1ctn

Facial Tissue



Hygiene Bath Tissue (HBT)

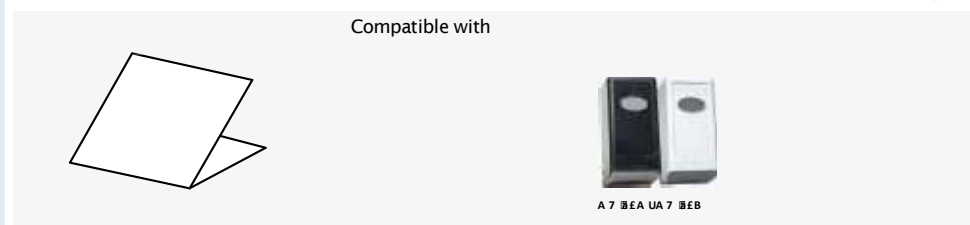

Code	Specification	Packing	Total Sheets
HBT 1 Ply Pulp	100mm x 200mm x 1ply	400 sheets x 36 packs x 1ctn	14400 sheets
HBT 2 Ply Pulp	100mm x 200mm x 1ply	250 sheets x 36 packs x 1ctn	9000 sheets
HBT 1 Ply Recycle	100mm x 200mm x 1ply	460 sheets x 36 packs x 1ctn	16560 sheets
HBT 2 Ply Recycle	100mm x 200mm x 1ply	250 sheets x 36 packs x 1ctn	9000 sheets



Facial Tissue

P88

Pop Up Tissue

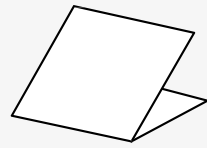

Compatible with



Code	Specification	Packing	Total Sheets
Clean Soft 2 Pulp	100mm x 200mm x 1ply	125 sheets x 72 packs x 1ctn	9000 sheets
Pearly Pulp Emboss	100mm x 200mm x 1ply	150 sheets x 72 packs x 1ctn	10800 sheets
Pearly Pulp Emboss	100mm x 200mm x 1ply	250 sheets x 72 packs x 1ctn	18000 sheets

P89

Facial Tissue Box

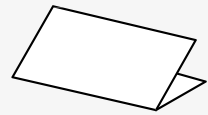

Code	Specification	Packing
Facial 40 / 50 Pulp	180mm x 200mm x 2ply	40 / 50 sheets x 72 packs x 1ctn
Facial 90 Pulp	180mm x 200mm x 2ply	90 sheets x 80 box x 1ctn
Facial 50 / 100 Cube Pulp	180mm x 200mm x 2ply	50 / 100 sheets x 100 box x 1ctn
Facial Pulp Refill Pack	2ply	500 pcs x 30 pack x 1ctn 800 pcs x 10 pack x 1ctn 1000 pcs x 10 pack x 1ctn

Toilet Tissue

P90

Bathroom (Small Toilet) Roll Tissue

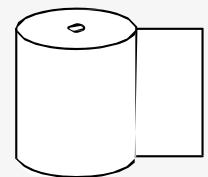

Compatible with



Code	Specification	Packing
STR 130 Pulp	130 sheets x 1 roll (2ply)	10 rolls x 10 packs x 1 bundle
STR 200 Pulp	200 sheets x 1 roll (2ply)	10 rolls x 10 packs x 1 bundle
STR 140 Recycle	140 sheets x 1 roll (2ply)	10 rolls x 10 packs x 1 bundle
STR 160 Recycle	160 sheets x 1 roll (2ply)	10 rolls x 10 packs x 1 bundle
STR 200 Recycle	200 sheets x 1 roll (2ply)	10 rolls x 10 packs x 1 bundle



Toilet Tissue

P91

Jumbo Roll Tissue (JRT)



Compatible with



Code	Specification	Packing
JRT 130 Pulp	130 meter x 1 roll (2ply)	12 rolls x 1ctn
JRT 200 Pulp	200 meter x 1 roll (2ply)	12 rolls x 1ctn
JRT 250 Pulp	250 meter x 1 roll (2ply)	12 rolls x 1ctn
JRT 400 Recycle	400 grams x 1 roll (2ply)	12 rolls x 1ctn
JRT 550 Recycle	550 grams x 1 roll (2ply)	12 rolls x 1ctn
JRT 600 Recycle	600 grams x 1 roll (2ply)	12 rolls x 1ctn
JRT 700 Recycle	700 grams x 1 roll (2ply)	12 rolls x 1ctn
JRT 200 Meter Recycle	200 meter x 1 roll (2ply)	12 rolls x 1ctn
JRT Single Ply Recycle	500 meter x 1 roll (1ply)	12 rolls x 1ctn

Industrial Tissue

P92

Industrial Tissue



Compatible with



Code	Specification	Packing
Industrial Roll Tissue (IRT)Pulp	26cm x 1000 meter x 1ply	2 rolls x 1ctn

Restaurant Tissue

P93

Serviette

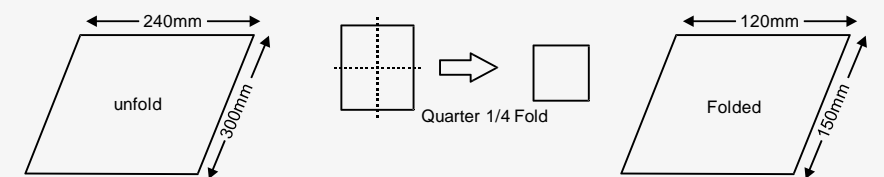

Code	Specification	Packing
Serviette Pulp	30cm x 24cm x 1ply	100s x 60pack x 1ctn 50gm x 60pack x 1ctn 100gm x 60pack x 1ctn
Serviette Recycle	30cm x 23cm x 1ply	60gm x 60pack x 1ctn 100 gm x 60pack x 1ctn

Description : 1/4, full emboss [Pink / white]

Restaurant Tissue Others



Cocktails Napkins

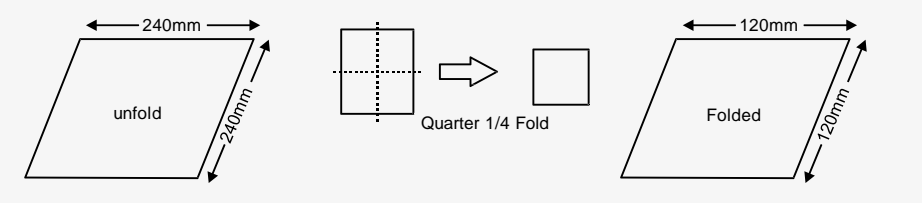

Code	Specification	Packing	Total Sheets
Cocktails 1ply Pulp	240mm x 240mm x 1ply	250 sheets x 20 packs x 1ctn (Plastic) 200 sheets x 25 packs x 1ctn (Box)	5000 sheets 5000 sheets
Cocktails 2ply Pulp	240mm x 240mm x 2ply	100 sheets x 50 packs x 1ctn (Plastic) 250 sheets x 20 packs x 1ctn (Box)	5000 sheets 5000 sheets
Cocktails Kraft Recycle	240mm x 240mm x 2ply	100 sheets x 50 packs x 1ctn	5000 sheets
Cocktails Quilted Pulp	240mm x 240mm x 1ply	250 sheets x 24 packs x 1ctn	5000 sheets

Note: Logo Printing Available



Luncheon Napkins

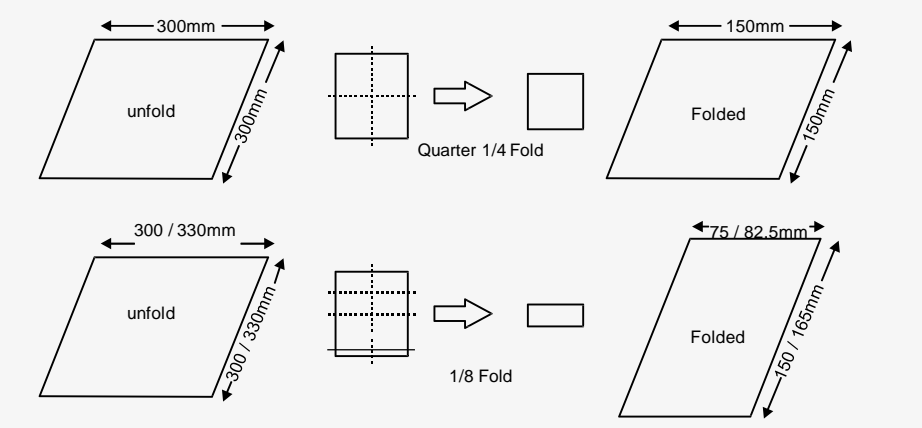

Code	Specification	Packing	Total Sheets
Luncheon Big 1ply Pulp	330mm x 330mm x 1ply	200 sheets x 30 packs x 1ctn	6000 sheets
Luncheon Big 2ply Pulp	330mm x 330mm x 2ply	100 sheets x 30 packs x 1ctn	3000 sheets
Luncheon Small 1ply Pulp	300mm x 300mm x 1ply	200 sheets x 30 packs x 1ctn	6000 sheets
Luncheon Small 2ply Pulp	300mm x 300mm x 2ply	100 sheets x 30 packs x 1ctn	3000 sheets
Luncheon Kraft Recycle	310mm x 320mm x 2ply	100 sheets x 30 packs x 1ctn	3000 sheets

Note: Logo Printing Available



Dinner Napkins

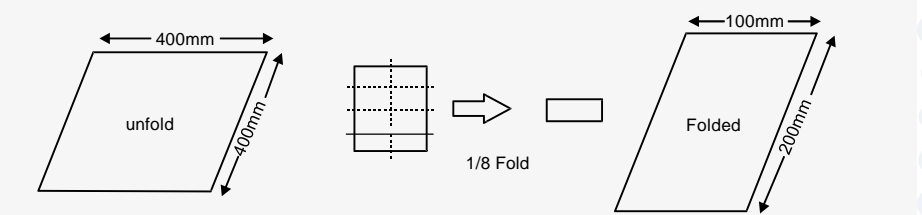

Code	Specification	Packing
Dinner 1ply Pulp	400mm x 400mm x 1ply	250 sheets x 12 packs x 1ctn
Dinner 2ply Pulp	400mm x 400mm x 2ply	100 sheets x 20 packs x 1ctn
Dinner Kraft Recycle	400mm x 400mm x 2ply	100 sheets x 20 packs x 1ctn
Dinner Quilted Pulp	400mm x 400mm x 1ply	100 sheets x 10 packs x 1ctn

Note: Logo Printing Available



Kitchen Towel



Code	Specification	Packing
Kitchen Towel Pulp	60 sheets x 228mm x 2ply	6 rolls x 4packs x 1ctn
Kitchen Towel Recycle	80 sheets x 215mm x 2ply	2 rolls x 10packs x 1ctn



Wet Tissue

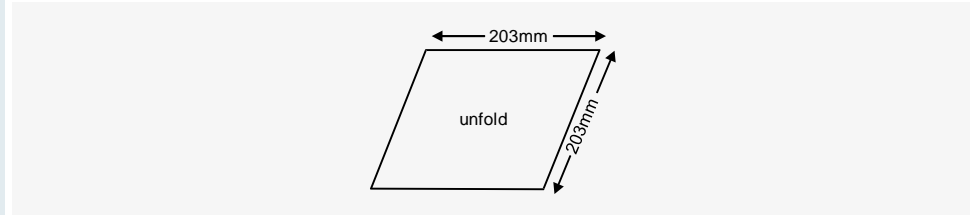

Code	Specification	Packing
Wet Tissue Plastic Colour: Pink, Red, Yellow, Maroon, Purple, Blue, White	230mm x 203mm x 1ply	100 pcs x 10 packs x 1ctn
Wet Tissue Aluminium Foil Colour: Silver, Light Green, Golden, Black, Red, Yellow, Maroon, Purple	203mm x 203mm x 1ply	100 pcs x 10 packs x 1ctn

Note: Logo Printing Available



Laminated Tissue Coaster

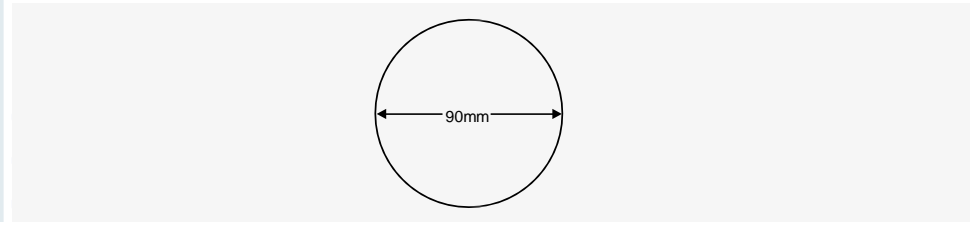

Code	Specification	Packing
Laminated Paper Coaster	90mm Diameter	500 pcs x 20 packs x 1ctn

Note: Logo Printing Available

Your Washroom Hygiene Partner



Air Freshener Dispenser

<p>P100</p>  <p>AW 101 C Compatible Open Up , 250ml Refill Battery : 2 unit AA size 90 X90 X220 (H)mm</p>	<p>P101</p>  <p>AW 102 D Compatible Open Up II, 250ml Refill Battery : 2 unit AA size 90 X90 X220 (H)mm</p>	<p>P102</p>  <p>AW105 F Compatible D Scent Diffuser, D Scent Refill Battery Free Operated 65 X65 X140 (H)mm</p>	<p>P103</p>  <p>AW110 B Compatible Digital Air Killer 250ml refill Battery : 2 unit AA size 86 x 81 x 220 (H) mm</p>
<p>P104</p>  <p>AW 111 Compatible Popular, Battery : 2 unit D size 250ml & 300ml Refill 85 X81 X238 (H) mm</p>	<p>P105</p>  <p>AW 111A Compatible Energy Saver, Battery : 2 unit AA size 250 & 300 ml 70 X85 X220 (H) mm</p>	<p>P106</p>  <p>AW 111B Compatible Energy Digital Battery : 2 unit AA size 65 X75 X220 (H) mm</p>	<p>P107</p>  <p>AW 112 Compatible Vintage Killer, Battery : 2 unit D size 250ml & 300ml Refill 85 X81 X238 (H) mm</p>
<p>P108</p>  <p>AW 113 Compatible Economy, Battery last up to 3 months. Non-stop 24 hours fragrance spray 2AA size battery (Alkaline), Material: PP Adjustable spray interval setting: 8, 15, 25 minutes Size : 86 x 82 x 200 Ht (mm)</p>	<p>P109</p>  <p>AW 103D Compatible Mini LCD (High Performance) Chemical Resistant - Polypropylene Cover 2pcs C Size Battery can last for 15 cans of refill. Size : 84 x 57 x 172 Ht (mm)</p>	<p>P110</p>  <p>AW 115C Compatible Fan Type, Energy Save Fibre Wick Refill Battery : 2 unit AA size</p>	<p>P111</p>  <p>AW 115D Compatible Fan Type Killer, Material: ABS Dimensions: 88 x 85 x 187 Ht (mm) Battery: 2 x AA size batteries, last up to 3 months.</p>

Hand Dryer

<p>P112</p>  <p>AW 301 Prima I 150 X270 X200 (H) mm Voltage : 220V /50Hz Rated power : 1600W Current : 7.2A Water splash proof : IPX1 Blowing volume :162.4m3/h Air speed : 10.6M/S Dimensions : 268 (L) x 150 (W) x 200 (H) mm Unit weight : 3.85kg Aluminum-alloy casing. Auto infrared sensor, quick time reaction. Water-proof and fire-resistant coating. Quiet, powerful, long-life motor.</p>	<p>P113</p>  <p>AW 302 Prima II 210 X240 X230 (H) mm ABS Casing Voltage : AC 230V / 50 Hz Power : 1800W Blowing volume : 210(L) X240(W) X230(H)mm Double Overheating Protection Waterproof grade: IPX1 Low Noise : <60dB</p>	<p>P114</p>  <p>AW 304 A Prima IV 270 x 142 x 235 (H) mm Voltage: 220V-50Hz Power capacity: 2300W Sensing distance: 12±5cm One-time work period: less than or equal to 60 seconds Cut-out temperature of heat protector: 125 degree Blowing volume : 270m3/hr Thermal air temperature: 45-70degree Wind speed: 30m/s Drying time: 10-15seconds Waterproof grade: IPX1 Size: 270(L) X142(W) X235(H)mm Gross weight: 5 kg</p>	<p>P115</p>  <p>AW 305 A Prima V 220 X300 X680 (H) mm Turbo Jet Hand Dryer Polycarbonate ABS Casing Voltage: 220V Frequency: 50Hz - 60Hz Power: 1650W (Motor: 650W) Air wind Speed: 90 m/s Water splash Proof: IPX1 Weight: 11kg QC: CE Certification Drying time: 5-7 seconds Air Selection: Cool / Warm Sensing distance : 12mm Energy saving</p>
----------------------------------------------------------------------------------------------------------------------------------------------------------------------------------------------------------------------------------------------------------------------------------------------------------------------------------------------------------------------------------------------------------------------------------------------------------------------------------------------------------------------------------------------------------	-----------------------------------------------------------------------------------------------------------------------------------------------------------------------------------------------------------------------------------------------------------------------------------------------------------------------------------------------------------------	---------------------------------------------------------------------------------------------------------------------------------------------------------------------------------------------------------------------------------------------------------------------------------------------------------------------------------------------------------------------------------------------------------------------------------------------------------------------------------------------------------------------------------------------------------------------------------	-------------------------------------------------------------------------------------------------------------------------------------------------------------------------------------------------------------------------------------------------------------------------------------------------------------------------------------------------------------------------------------------------------------------------------------------------------------------------------------------------------------



Soap Dispenser

<p>P116</p> <p>AW 200 A 800ml Refillable & Cartridge 110 x 120 x 235 (H) mm</p>	<p>P117</p> <p>AW 201 C Multi Slim Capacity : 400ml, 800ml Refillable & Cartridge Optional- Liquid, Foam, Mist Spray Stainless Steel Spring Valve 110 x 120 x 235 (H) mm</p>	<p>P118</p> <p>AW 202 Compact Refillable, 1000 ml Stainless Steel Spring Valve 95 x 130 x 230 (H) mm</p>	<p>P119</p> <p>AW 203 C Tube Button 800ml Refillable & Cartridge Silicone Tube Valve 135 x 85 x 240 (H) mm</p>
<p>P120</p> <p>AW 204 A Killer Soap Pump Valve 1000ml Refillable 95 x 125 x 230 (H) mm</p>	<p>P121</p> <p>AW 205 C Tinted Transparent 800ml Refillable & Cartridge Silicone Tube Valve 133 x 90 x 235 (H) mm</p>	<p>P122</p> <p>AW 206 A Aero S Pump Valve 1000 ml Refillable 100 x 125 x 228 (H) mm</p>	<p>P123</p> <p>AW 207 B Auto sensor 2 1000ml Refillable & Cartridge Optional - Liquid, Mist Spray 4 Pcs C Size Battery, 0.5 ml / Shot 113 x 122 x 220 (H) mm</p>
<p>P124</p> <p>AW 208 B Auto Foam 1000ml Refillable & Cartridge Foam Soap, Foam Sanitiser 4 Pcs C Size Battery, 0.5 ml / Shot 113 x 122 x 260 (H) mm</p>	<p>P125</p> <p>AW 209 Transparent I Refillable, 800ml, Stainless Steel Spring Valve 100 x 120 x 200 (H) mm</p>	<p>P126</p> <p>AW 210 C Transparent II Refillable, 900ml Heavy Duty Smooth Spring Valve 90 x 80 x 175 (H) mm</p>	<p>P127</p> <p>AW 216 B Foam Soap I, 800ml, Tube Valve Optional - Liquid, Mist Spray 133 x 88 x 260 (H) mm</p>
<p>P128</p> <p>AW 211 Mastafill Heavy Duty Smooth Spring Valve 1000 mL (Made In England) 100 x 120 x 285 (H) mm</p>	<p>P129</p> <p>AW 212 Vertical I Stainless Steel Container, 1200ml Stainless Steel Pump Valve 120 x 125 x 210 (H) mm</p>	<p>P130</p> <p>AW 213 A Horizontal Stainless Steel 1200ml Stainless Steel Pump Valve 200 x 70 x 115 (H) mm</p>	<p>P131</p> <p>AW 214 Mini Killer Material : ABS Casing, Pump Valve Optional- Liquid, Foam, Mist Spray 80 x 70 x 200 (H) mm</p>
<p>P132</p> <p>AW 215 A Counter Top Copper Pump Valve, Capacity : 400 ml 52 Dia x 260 (H) mm</p>	<p>P133</p> <p>AW 217 B Double Killer Optional- Liquid, Foam, Mist Spray Capacity : 2 x 400ml, 80 x 145 x 200 (H) mm</p>	<p>P134</p> <p>AW 219 B Double Compartment II Heavy Duty Smooth Silicone Valve Capacity : 2 x 350 ml, 136 x 90 x 215 (H) mm</p>	<p>P135</p> <p>AW 220 A Foot Operated Surgical Soap Dispenser Capacity : 950 ml 114 x 105 x 195 (H) mm</p>

Jumbo Roll Dispenser



<p>P136</p> <p>AW 401 High Impact 120 x 280 x 300 (H) mm</p>	<p>P137</p> <p>AW 402 A Solid 120 x 260 x 300</p>	<p>P138</p> <p>AW 403 A 277 x 110 x 294 (H) mm</p>	<p>P139</p> <p>AW 404 Jumbo Killer 270 x 114 x 310 (H) mm</p>
<p>P140</p> <p>AW 405 A Tinted Transparent 270 x 127 x 301 (H) mm</p>	<p>P141</p> <p>AW 406 Hammer Head Dim: 280L x 120D x 310H (mm)</p>	<p>P142</p> <p>AW 407 Center Lock Stainless Steel Dim: 255L x 120D (mm)</p>	<p>P143</p> <p>AW 408 Toilet Roll Holder Dim: 260L x 125D (mm)</p>
<p>P144</p> <p>AW 409 Double Roll JRT Dispenser 506 x 123 x 305 (H) mm</p>	<p>P145</p> <p>AW 410 Stainless Steel Twin Jumbo Roll Dispenser 520 x 140 x 285 (H) mm</p>	<p>P146</p> <p>AW 420 Stainless Steel Half Cover Toilet Roll Holder 506 x 123 x 305 (H) mm</p>	<p>P147</p> <p>AW 421 Stainless Steel Flat Cover Toilet Roll Holder</p>

Paper Towel Dispenser

<p>P148</p> <p>AW 501 B Tinted Transparent 275 x 118 x 372 (H) mm</p>	<p>P149</p> <p>AW 502 B Better 275 x 118 x 372 (H) mm</p>	<p>P150</p> <p>AW 503 C Multi Killer 272 x 131 x 385 (H) mm</p>	<p>P151</p> <p>AW 504 A Mini Fold Dim: 250L x 110D x 233H (mm)</p>
--------------------------------------------------------------------------------------	--------------------------------------------------------------------------	--------------------------------------------------------------------------------	-----------------------------------------------------------------------------------



Paper Towel Dispenser

<p>P127</p>  <p>AW 505 Mini Fold II 260 x 126 x 292 (H) mm</p>	<p>P153</p>  <p>AW 505 A Transparent Economy 243 x 110 x 168 (H) mm</p>	<p>P154</p>  <p>AW 506 Elegance Stainless Steel 280L x 101D x 360H (mm)</p>	<p>P155</p>  <p>AW 507 Innovative Stainless Steel 275L x 113D x 400H (mm)</p>
<p>P156</p>  <p>AW 508 Stainless Steel 2 In 1 paper Towel Dispenser & Disposal Size : 300 x 140 x 750 (H) mm (Wall Mouted)</p>	<p>P15</p>  <p>AW 509 Stainless Steel 2 In 1 Paper Towel Dispenser & Disposal 280 x 140 x 730 (H) mm (Recessed)</p>	<p>P158</p>  <p>AW 510 Stainless Steel Henjo Shape 250 x 150 x 330(H) mm</p>	<p>P159</p>  <p>AW 511 Stainless Steel Mini 280 x 100 x 240(H) mm</p>

Urinal Sanitizer Dispensers

<p>P160</p>  <p>AW 601 A Auto Urinal - 108 x 90 x 228 (H) mm Dispensing Volume : 0.12 ml / press 2x AA Size Battery</p>	<p>P161</p>  <p>AW 602 Flushing System I 120L x 76D x 224H (mm)</p>	<p>P162</p>  <p>AW 603 A Auto Urinal II 2x AA Size Alkaline Battery last for 15 Refill Capacity : 400 ml 1 to 59 minute interval</p>	<p>P163</p>  <p>AW 604 Dripping System 120L x 76D x 244H (mm)</p>
-------------------------------------------------------------------------------------------------------------------------------------------------------------------------------------------------------------------------------	-----------------------------------------------------------------------------------------------------------------------------------------------------------------------	-------------------------------------------------------------------------------------------------------------------------------------------------------------------------------------------------------------------------------------------------	-----------------------------------------------------------------------------------------------------------------------------------------------------------------------

Sanitary Pedal Bins

<p>P164</p>  <p>AW 2001 Slim 190L x 332D x 600H (mm) Pedal, 18 Liters</p>	<p>P165</p>  <p>AW 2001 A Slim II 190L x 332D x 600H (mm)</p>	<p>P166</p>  <p>AW 2003 Side Open 550 x 152 x 570 (H) mm Material : cover ABS body polypopylene</p>	<p>P167</p>  <p>AW 2005 495 x 140 x 550 H (mm) Material : Cover ABS, Body Polypropylene (PP) 4pcs AA Alkaline Battery Can last upto 8,000 time open. 22 liters</p>
---------------------------------------------------------------------------------------------------------------------------------------------------------------------------------	-----------------------------------------------------------------------------------------------------------------------------------------------------------------	------------------------------------------------------------------------------------------------------------------------------------------------------------------------------------------------------------	--------------------------------------------------------------------------------------------------------------------------------------------------------------------------------------------------------------------------------------------------------------------------------



*æ 1 « DÃ«iÃiÀ U->Î>ÀP B>}
DÃ«iÃiÀ UHP }i ã B>IÀwÃÃÕi DÃ«iÃiÀ

<p>P168</p>  <p>AW 701 C Mist Spray - 133 x 90 x 235 (H) mm 500ml , 800ml Cartridge, 1.2ml / Press</p>	<p>P169</p>  <p>AW 702 Mist Spray 900 x 100 x 181 (H) mm 400ml Cartridge, 0.4ml/Press</p>	<p>P170</p>  <p>AW 801 A Sanitary Bag Dispenser 115 x 41 x 159 (H) mm</p>	<p>P171</p>  <p>A 7 ÆA UA 7 ÆB HBT Dim: 125L x 113D x 170H (mm)</p>
<p>P172</p>  <p>AW 001 Pop Up Dispenser 113 x 72 x 159 (H) mm</p>	<p>P173</p>  <p>AW 002 Pop Up With Side Clip 113 x 80 x 127 (H)mm Material : ABS , 24pcs / carton</p>	<p>P174</p>  <p>AW 003 Pop Up With Side Slot Compartment</p>	<p>P17</p>  <p>AW 004 Pop Up Colourful 115 x 115 x 77 (H) mm Material : Polypropylene, 120 pcs / carton</p>

Hand Roll Towel Dispenser Center Pull Towel Dispenser

<p>P176</p>  <p>AW 1001 A Auto Cut 340 x 225 x 375 (H) mm</p>	<p>P177</p>  <p>AW 1002 Manual I Dim: 380L x 277D x 222H (mm)</p>	<p>P178</p>  <p>AW 1003 Manual II Dim: 332L x 280D x 240H (mm)</p>	<p>P179</p>  <p>AW 1100 A Local Star 285 x 315 (H) mm</p>
<p>P180</p>  <p>AW 1101 Center Pull Killer 230 x 227 x 350 (H) mm</p>			

Put Trash In Its Place



HIPPO 2-Wheeled Waste Container



P181



120 Litre

240 Litre

Technology : Injection Moulded

Lif-Body Attachment : Two Plastic Pivots

Material : High-Density Polyethylene (HDPE) UV Stabilized

Colours : Green, Orange, Blue, Yellow, Black and Grey

Wheel : 2 Solid Rubber Wheels with Corrosion Resistant Steel Shaft

Origin : Manufactured in Malaysia

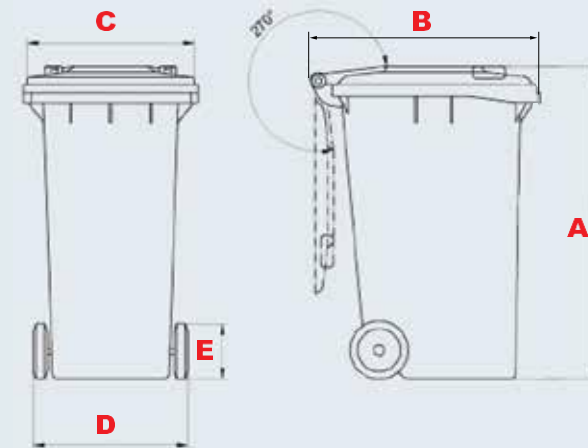

MGM - 2 Wheeled Bins	120 L	240 L
Nominal Volume (l)	120	240
Nominal Payload (kg)	60	110
Dead Weight (kg)	8.26	10.42
A Total Height (mm)	977	1020
B Total Depth (mm)	524	740
C Total Width (mm)	478	590
D Travelling Gear, Width	470	550
E Wheel - Ø (mm)	200	200

Specification : EN840 Europe Standard



Corrosion Resistant Steel Shaft



Spare Parts Are Separately Replaceable



Solid Rubber Wheel



P182
Pedal Bin PB302-45L
 410W x 390D x 600H (mm)
Pedal Bin PB302-68L
 500W x 400D x 650H (mm)



P183
Clinical Waste Pedal Bin
10L : 260 x 330H (mm)
20L : 320 x 420H (mm)
35L : 375 x 540H (mm)



P184
 Clinical Waste Bin 45L c/w
 Powder Coating Pedal & Trolley
 440W x 560D x 930H (mm)



P185
Honey 85
 630D x 730H (mm)



P198
SWEETY 85
 with INNER LINER
 450D x 1010H (mm)
 Option : ASHTRAY



P199
SUNNY 85
 400D x 630H (mm)
SUNNY 80
 475D x 810H (mm)



P200
SUMMER 150
 630D x 940H (mm)
 Option : ASHTRAY



P201
SUGUTA 40
 Majestic 85 with Inner Bin
 345D x 605H (mm)



P186
Round Pedal Bin 10L
 260D x 330H (mm)
Round Pedal Bin 18L
 315D x 405H (mm)
Round Pedal Bin 35L
 375D x 540H (mm)



P187
Winter 85 c/w Inner Liner
 450D x 1010H (mm)
 Option : ASHTRAY



P188
WILD 85
 430W x 430D x 1000H (mm)
 Option : ASHTRAY



P189
WADI 45
 440H x 300D x 720H (mm)



P202
ZARA 68 with Inner Liner
 Swing Top 33L
 385 x 275 x 530 (H) mm
 Swing Top 45L
 405 x 290 x 670 (H) mm
 ASHTRAY : PE LID



P203
YALA 25
 Top Opening
 250D x 630H (mm)



P204
YALA 25
 Swing Top
 250D x 630H (mm)



P205
WOKIRO 90
 380D x 950H (mm)
 Option : ASHTRAY



P190
STEP ON BIN 87L
 500W x 410D x 820H (mm)
 Colour : Yellow, Grey, Blue, Green



P191
ZARA 68 With INNER LINER
 400D x 830H (mm)
 Option : Stainless Steel Lid With ASHTRAY



P192
VOLTA 80
 Fibreglass Open Top Square Bin
 345W x 345D x 820H (mm)



P193
VIRGO 80
 430D x 1080H (mm)
VIRGO 150
 520D x 1140H (mm)



P206
ZARA 68 with Inner Liner
 400D x 830H (mm)
 Option : Stainless Steel Lid with Open Top



P207
KISO 65 430D x 690H (mm)
KISO 95 560D x 750H (mm)
KISO 120 610D x 900H (mm)



P208
KENYA 16
 254D x 600H (mm)



P209
LIBRA 120
 490W x 490D x 1040H (mm)
 Option : ASHTRAY



P194
VICTORIA 75
 380W x 245D x 745H (mm)
 Options : Stainless Steel Lid Swing Top & Stainless Steel Lid Top Opening



P195
Umbrella Bin
 370D x 645H (mm)



P196
TAURUS 100
 470D x 1000H (mm)
 Option : ASHTRAY



P197
ZARA 68 with Inner Liner
 400D x 830H (mm)
 Option : PE Lid With ASHTRAY



P210
KK 85 with Inner Liner
 440D x 1100H (mm)
 Option : ASHTRAY



P211
MAJESTIC 85 with Inner Bin
 560D x 1080H (mm)
 Option : ASHTRAY



P212
Swing Top 33L
 385 x 275 x 530 (H) mm
Swing Top 45L
 405 x 290 x 670 (H) mm



P213
NANA 70
 315W x 315D x 700H (mm)

P214



SUMMER 150
630D x 940H (mm)

P215



OLYMPIC 30
with ASHTRAY Top and Inner Bin
285D x 815H (mm)

P216



MONTANA 150
575D x 1010H (mm)
Option : ASHTRAY

P217



LIBRA 180
540W x 540D x 1050H (mm)
Option : ASHTRAY

P230



ARIES 16
with Stainless Steel Ashtray Top
245D x 580H (mm)

P231



Daisy
Stainless Steel Top opening Cover
with Inner Liner
355W x 355L x 770Ht (mm)

P232



PUSH Down 23 L 340 x 240 x 450 (H) mm
PUSH Down 40 L 410 x 330 x 610 (H) mm
PUSH Down 60 L 410 x 410 x 700 (H) mm

P233



Park Bin
Powder Coated + Wooden Square Bin
Complete With AshTray
& GI Inner Bin
350L x 350W x 810 Ht mm

P218



MAGIC 50
380W x 380D x 790H (mm)
Option : ASHTRAY

P219



RIANA 60
with Bracket & Post
300W x 350D x 790H (mm)

P220



OPEN TOP 35
with Stainless Steel Top Opening Cover
300D x 710H (mm)

P221



OLYMPIC 50
with Ashtray Top and Inner Bin
370D x 815H (mm)

P234



Chemical Tanks
200L : 640Dx840 Ht (mm)
350L : 770D x 1020 Ht (mm)
550L : 850D x 1160 Ht (mm)

P235



GUWA
245D x 300H (mm)
Stainless Steel Lid TopOpening
& Stainless Steel Lid Swing Top

P236



Fire Resistance Room Bin
275W x 210D x 315H (mm)

P237



Gemini Room Bin
240D x 190D x 290H (mm)

P222



KOKA 90
PUSH Down 23 Liters
340 x 240 x 450 (H) mm
PUSH Down 40 Liters
410 x 330 x 610 (H) mm
PUSH Down 60 Liters
410 x 410 x 700 (H) mm
Option : ASHTRAY

P223



OLYMPIC 16
245D x 645H (mm)
Option : ASHTRAY

P224



MOON 45
Fibreglass Semi Round Bin Open Top
450W x 225D x 730H (mm)

P225



ICE 45
Fibreglass Semi Round Bin
with Ashtray Top
450W x 225D x 730H (mm)

P238



FGLT-512/FG
980W x 680D x 840H (mm)
FGLT-514/FG
960W x 745D x 780H (mm)
Fibreglass Laundry Trolley with 100D
(mm) Rubber Wheels

P239



DRUM
95L : 500 x 410 x 600(H) mm
150L : 600 x 600 x 650(H) mm
200L : 640 x 640 x 700(H) mm
250L : 690 x 690 x 740(H) mm

P240



GORA 120
640D x 1010H (mm)
Option : ASHTRAY

P241



PB004-G
Mobile Drum , Complete with Metal
Frame Trolley, Capacity : 150liters
650 x 600 x 800 Ht (mm)

P226



BLUE SEA 45
Fibreglass Semi Round Bin with
1/3 Ashtray & 2/3 Open Top
450W x 225D x 730H (mm)

P227



MOUNTAIN 80
with Stainless Steel Cover
360W x 360D x 790H (mm)

P228



DAMAS 95
with Inner Liner & Ashtray
480D x 1020H (mm)

P229



CAMELIA 30
360W x 255D x 520H (mm)

P242



ENERGY 50
350D x 800H (mm)
Options : Ashtray

P243



GOLDEN 16
250W x 250D x 560H (mm)
DOLDEN 60
395W x 395D x 790H (mm)
Options : Ashtray

P244



HAPPY 28
370W x 265D x 500H (mm)
Options : Ashtray

P245



JORDON 45
Semi Round Bin C/W Open Top
495W x 255D x 745H (mm)

P246



FOREST 40
505W x 320D x 765H (mm)
Options : Ashtray

P247



FLIP 60
395W x 395D x 800H (mm)
FLIP 120
485W x 485D x 1000H (mm)

P248



EVEREST 50
380W x 380D x 820H (mm)
EVEREST 120
510W x 510D x 1080H (mm)

P249



K250
350D x 850H (mm)
Options : Ashtray

P250



HADDAS 40
483D x 660H (mm)

P251



MFR 1 (Fiberglass)
1180 (L) x 400 (W) x 800mm (Ht)

P252



MFR 2 (HDPE)
245mm Dia X 650mm Ht

P253



Recycling Semi Round (Fiberglass)
450 (L) x 230mm (W) x 730 mm (Ht)

P254



Recycling PE 50 (HDPE)
400 x 400 x 780mm Ht

P255



Recycling Step On 45L (PE)
410 x 390 x 600mm Ht

P256



Recycling Step On 68L (PE)
500 x 400 x 650mm Ht

P257



Recycling 120 Liter Flip Top (HDPE)
470 x 550 x 1070mm Ht

P258



Recycling Swing Top 30L (PE)
385 x 275 x 530mm Ht

P259



Recycling Kiddo 40
483mm (D) x 660mm (H)

P260



Recycling Liza 90
Stainless Steel Top Load
770mm (H) x 355mm (W) x 355mm (L)

P261



Recycling NC 90+1
Stainless Steel Top Load
770mm (H) x 355mm (W) x 355mm (L)

P262



Recycling Lucky 68 (HDPE)
Top Load , Stainless Steel Top
400 Dia x 830mm Ht

P263



Recycling Metal Leach Bin 1500L
1370 x 1650 x 990mm Ht
Customized Recycling Labels Available

P264



Recycling MGB 240L Push Cover Complete With Signage Stand
580 x 730 x 1210mm Ht
Customized Recycling Labels Available
Material : Inkjet Sticker On HIP Board

P265



Recycling MGB 240L (Flat Cover)
590 x 740 x 1020mm Ht
Customized Recycling Labels Available (Optional)

P266



Recycling Pe 50 (New Colour)
380 x 380 x 800 (mm)

P267



Recycling Round Multi Colour (HDPE)
400 Dia x 965mm Ht
Customized Recycling Labels Available (Optional)

P268



Recycling Sheilla 70 (HDPE)
Stainless Steel Top (Optional)
355 x 355 x 700mm Ht

P269



Recycling Swing 50 & 120 (NC)
380 x 380 x 830 Ht
550 x 550 x 10800

P270



Recycling Swing 50 (HDPE)
375L x 380 W x 965mm Ht

P271



Recycling Tiffany 75 Swing Top
380L x 425 W x 745mm Ht

P272



Recycling Lucky 68 (HDPE)
400 Dia x 830mm Ht
Stainless Steel Top (Optional)
Customized Recycling Labels Available (Optional)

P273



Recycling Bin 4 Compartment
1650L x 480W x 900H (mm)



P274
20 & 50 Liters Pedal Bin
Metal Frame Base



P275
20 Liter Square Pedal Bin
Metal Frame Base



P276
Dual Purpose Medical Waste Bin
Complete With
Powder Coated Pedal & Trolley



P277
Mobile Sharp Bin Holder



P278
2.5 Liters 5 Liters 10 Liters 20 Liters
Sharp Bin



P279
Trocar Bin
Capacity : 2.4 Liters
British Standards BS 7320 : 1990 and are
approved by SIRIM. Clear warning labeling
Leak, spill & pilfer proof Aperture Cover.
Safe & strong



P280
Trocar Bin Holder



P281
Powder Coated Pedal & Trolley for
Medical Waste Bin (Suitable for
18 Liter to 45 liter Round Bin)



P282
Clinical Waste 120 Liters



P283
Clinical Waste 240 Liters



P284
Clinical Waste 660 Liters



RORO BIN

A. Standard Size
12 CU.YD - 4 FOOTER
12f (L) X 6f (W) X 4f (H)
MAX LOAD: 5 TONS
FACTORY & BULKY WASTE

B. Medium Size
22 CU.YD- 4 FOOTER
18f (L) X 8f (W) X 4f (H)
MAX LOAD: 20 TONS (10 WHEELER)
CONSTRUCTION WASTE
MAX LOAD: 14 TONS (6 WHEELER)
FACTORY & BULKY WASTE

C. Large Size
22 CU.YD- 6 FOOTER
18f (L) X 8f (W) X 6f (H)
MAX LOAD: 20 TONS (10 WHEELER)
CONSTRUCTION WASTE
MAX LOAD: 14 TONS (6 WHEELER)
FACTORY & BULKY WASTE



P286
HIPPO 660 L
Metal Leach Bin 660 Liters



P287
HIPPO 1100 L
Metal Leach Bin 1100 Liters



P288
Metal Leach bin 1500 liters
2mm Thickness Mild Steel
Colour : Blue, Green
2010 (L) x 1310 (W) x 1180 (H) mm



P289
Metal Leach Bin 1100 liters
2mm Thickness Mild Steel
Colour : Blue, Green
1650 (L) x 1350 (W) x 990 (H) mm





P289
Plastic Leach Bin 1500 Liters
Polyethylene Bin + Metal Frame
2010 (L) x 1420 (W) x 1170 (H) mm



















P289
Plastic Leach Bin 1100 Liters
Polyethylene Bin + Metal Frame
1650 (L) x 1350 (W) x 990 (H) mm



Type	Code	Size	Dimension	Colour	UOM	Remarks
Garbage Bag	GB001	S	47cm x 54cm	Blue	1 Bundle (200 packets x 30pcs)	
	GB002 (PS)	S	47cm x 54cm (PS)	Black	1 Bundle (200 packets x 30pcs)	Thicker
	GB003	M	56cm x 84cm	Black	1 Bundle (150 packets x 30pcs)	
	GB004	L	74cm x 90cm	Black	1 Bundle (180 packets x 10pcs)	
	GB005 (PS)	L	74cm x 90cm	Black	1 Bundle (75 packets x 20pcs)	Thicker
	GB006-W	L	74cm x 90cm	White	1 Bundle (100 packets x 20pcs)	
	GB007	L	29" x 35" x 0.035mm	White	1 Bundle (25kg)	
	GB008	XL	32" x 40"	White	1 Bundle (30 packets x 10pcs+-)	
	GB009	XL	32" x 40" x 0.035mm	Black	1 Bdl (30 packets/800g/pkt (10@12pcs/pkt)	
	GB010	XL	35" x 40" (PS)	Black	1 Bundle (20 packets x 30pcs)	
	GB011	XL	35" x 40" x 0.025mm	Black	1 Bundle (10 packets x 50pcs)	
	GB012	XL	35" x 40" x 0.03mm	White	1 Bundle (10 packets) 2.5kg/pkt	
	GB013	XL	35" x 40"	Black	1 Bdl (30 packets/1kg/pkt (@11pcs/pkt)	
	GB014	XXL	38" x 45" x 0.025mm	White	1 Bundle/ 25kg (1 packets x 100pcs)	
	GB015	XXL	38" x 45" x 0.025mm	White	1 Bundle/ 25kg (1 packets x 100pcs)	
	GB016	XXL	38" x 45" x 0.025mm	White	1 Bundle/ 25kg	
	GB017	XXL	38" x 45" x 0.025mm	Black	1 Bundle (15 packets x 30pcs)	For MGB 120L
	GB018	XXXL	45" x 55" x 0.035mm	Black	1 Bundle (10 packets x 20pcs)	For MGB 240L
Room Bin	GB019		18" x 21" x 0.015mm	White	1 Bundle/ 25kg	For Hotel Room Bin
Sanitary Bag	GB020		19" x 29" x 0.03mm	Blue	1 Bundle (30 packets x 50pcs)	For Sanitary Bin

<p>P291</p>  <p>SRB-055/OT Stainless Steel Semi Round Bin C/W Open Top 345W x 170D x 660H (mm)</p>	<p>P292</p>  <p>SRB-059/F Stainless Steel Semi Round Bin C/W Flat Top 345W x 170D x 660H</p>	<p>P293</p>  <p>RBC-409S-E3-H Refuse Bin With Embossed, Punched & Top Opening 345L x 170W x 660H (mm) Volume : 14 Litres</p>	<p>P294</p>  <p>ASC-409S-E1-H Ashtray Waste Bin With Half Ashtray & Half Top Opening 345L x 170W x 660H (mm) Volume : 22 Litres</p>
<p>P295</p>  <p>SRB-044/OT Stainless Steel Semi Round Bin C/W Open Top 457W x 227D x 760H (mm)</p>	<p>P296</p>  <p>SRE-045/F Stainless Steel Semi Round Bin C/W Flat Top 475W x 227D x 760 H (mm)</p>	<p>P297</p>  <p>FT-031/S Stainless Steel Litter Bin C/W Flip Top 345D x 785H (mm)</p>	<p>P298</p>  <p>FT-302/S Stainless Steel Litter Bin C/W Flip Top, Embossed & Punch</p>
<p>P299</p>  <p>SRB-046/OT Refuse Bin With Top Opening, Embossed & Punched 345L x 170W x 660H (mm) Volume : 14 litre</p>	<p>P300</p>  <p>RB-1405SS Wheelie Bin Container 650L x 620W x 1210H (mm) Volume : 120L</p>	<p>P301</p>  <p>RB-1101S Ashtray & Waste Bin 510L x 530W x 850H (mm) Volume : 65 Litres</p>	<p>P302</p>  <p>RAB-149/OT Stainless Steel Waste Bin C/W Open Top & Ashtray 370W x 626D x 1155H (mm)</p>
<p>P303</p>  <p>ODB-161/SS Stainless Steel Waste Bin 362D x 847H (mm)</p>	<p>P304</p>  <p>RAB-148/OT Stainless Steel Waste Bin C/W Open Top & Ashtray 630W x 360D x 1100H (mm)</p>	<p>P305</p>  <p>ROB-158/OT Stainless Steel Rectangular Waste Bin C/W Open Top 450W x 600H x 1045H (mm)</p>	<p>P306</p>  <p>SQB-157/OT Stainless Steel Square Waste Bin C/W Open Top 500W x 500D x 1020H (mm)</p>

<p>P307</p>  <p>RAB-150/OT Stainless Steel Waste Bin C/W Open Top 460D x 1220H (mm)</p>	<p>P308</p>  <p>RAB-147/OT Stainless Steel Round Waste Bin C/W Open Top 530D x 975H (mm)</p>	<p>P309</p>  <p>RAB-143/F Stainless Steel Oval Waste Bin C/W Flat Top 640W x 410D x 1080H (mm)</p>	<p>P310</p>  <p>RB-825S Hygiene Ashtray & Waste Bin 380D x 765H (mm) Volume : 54 Litres</p>
<p>P311</p>  <p>RFT-155/SS Stainless Steel Rectangular Waste Bin C/W Swing Top 600W x 400D x 800H (mm)</p>	<p>P312</p>  <p>ROB-153/OT 430W x 280D x 750H (mm) ROB-154/OT 600W x 300D x 770H (mm)</p>	<p>P313</p>  <p>SQB-126/OT Stainless Steel Square Waste Bin C/W Open Top 300W x 300D x 610H (mm)</p>	<p>P314</p>  <p>IRB-405S-E1 Ashtray & Waste Bin 380L x 230W x 750H (mm) Volume : 33 Litres</p>
<p>P315</p>  <p>RB LEV-1404S-120L Ashtray & Waste Bin 600L x 400W x 120H (mm) Volume : 120 Litres</p>	<p>P316</p>  <p>SQB-156/SS Stainless Steel Square Waste Bin 500W x 500D x 850H (mm)</p>	<p>P317</p>  <p>ROB-151/OT 450W x 310D x 740H (mm) ROB-152/OT 450W x 310D x 600H (mm)</p>	<p>P318</p>  <p>RFT-018/SS Stainless Steel Rectangular Flip Top Bin 380W x 230D x 750H (mm)</p>
<p>P319</p>  <p>RB FIN-1403S-OV-70L Ashtray & Waste Bin 560L x 360W x 920H (mm) Volume : 70 Litres</p>	<p>P320</p>  <p>ODB-159/OT Stainless Steel Outdoor Waste Bin 735W x 322D x 1305H (mm)</p>	<p>P321</p>  <p>RAB-118/H Stainless Steel Round Waste Bin C/W Half Ashtray & Half Swing Top 345D x 785H (mm)</p>	<p>P322</p>  <p>LD-RAB-074/SS Stainless Steel Round Waste Bin C/W Open Top 250D x 600H (mm)</p>

Stainless Steel Bin

WASTE BIN

WASTE BIN

<p>P323</p>  <p>RFT-061/SS 250D x 600H (mm) RFT-062/SS 250D x 760H (mm)</p>	<p>P324</p>  <p>HB-162/SS Stainless Steel Hanging Bin 700W x 325D x 703H (mm)</p>	<p>P325</p>  <p>LD-ODB-096/SS Stainless Steel Outdoor Bin With Top Cover & Galvanised Steel Liner 350D (mm) Total Weight : 480mm Total Height : 1150m</p>	<p>P326</p>  <p>AS-BOWL-E1-D Refuse Bin With Dome Head & Embossed 295D x 760H (mm) Volume : 29 Litres</p>
<p>P327</p>  <p>AS-CD-E1 Ashtray Waste Bin With Embossed 295D x 760H (mm) Volume : 29 Litres</p>	<p>P328</p>  <p>AS-CD-E7 Ashtray Waste Bin With Embossed, Ashtray Top & Punched 295D x 760H (mm) Volume : 29 Litres</p>	<p>P329</p>  <p>AS-BOWL-D Stainless Steel Litter Bin C/W Ashtray Top 390D x 760H (mm)</p>	<p>P330</p>  <p>Stainless Steel Litter Bin C/W Ashtray Top RAB-001/A 245D x 600H (mm) RAB-002/A 245D x 760H (mm)</p>
<p>P331</p>  <p>SRB-058/A Stainless Steel Semi Round Bin C/W Ashtray Top 345W x 170D x 660H (mm)</p>	<p>P332</p>  <p>ASC-409S Ashtray Waste Bin 345L x 170W x 660H (mm) Volume : 14 Litres</p>	<p>P333</p>  <p>AS-BOWL-D Refuse Bin With Dome Head 390D x 760H (mm) Volume : 40 Litres</p>	<p>P334</p>  <p>RAB-052/SS Stainless Steel Litter Bin C/W Open Top 390D x 760H (mm)</p>
<p>P335</p>  <p>AS-BOWL-E1 Ashtray Waste Bin With Embossed & Ashtray Top 390D x 760H (mm) Volume : 40 Litres</p>	<p>P336</p>  <p>AS-BOWL Ashtray Waste Bin 390D x 760H (mm) Volume : 40 Litres</p>	<p>P337</p>  <p>RAB-146/H Stainless Steel Round Waste Bin C/W 1/2 Ashtray And 1/2 Open Top 390D x 800H (mm)</p>	<p>P338</p>  <p>RB-825-EXP Ashtray & Waste Bin 380D x 760H (mm) Volume : 54 Litres</p>

<p>P339</p>  <p>AS-825S-EXP Ashtray & Waste Bin 380D x 760H (mm) Volume : 40 Litres</p>	<p>P340</p>  <p>AS-CD-EXP Ashtray & Waste Bin 295D x 760H (mm)</p>	<p>P341</p>  <p>RAB-145/H Stainless Steel Round Waste Bin C/W Flip & Ashtray Top 395D x 910H (mm)</p>	<p>P342</p>  <p>AS FIN-1402S-RD-63L Ashtray & Waste Bin 450D x 1100H (mm) Volume : 63 Litres</p>
<p>P343</p>  <p>ODB-163/SS Stainless Steel Outdoor Waste 700D x TOP x 250D (mm) Bottom x 1075H (mm)</p>	<p>P344</p>  <p>SRB-054/H Stainless Steel Semi Round Bin C/W 1/3 Ashtray 2/3 Open Top 345W x 170D x 660H (mm)</p>	<p>P345</p>  <p>RAS-123/F Stainless Steel Rectangular Waste Bin C/W Flat Top 255W x 235D x 610H (mm)</p>	<p>P346</p>  <p>WMA-172/SS Stainless Steel Wall Mounted Ashtray Bin 250W x 150D x 500H (mm)</p>
<p>P347</p>  <p>Stainless Steel Wall Mounted Ashtray Bin WMA-168/SS 150W x 150D x 360H (mm) WMA-169/SS 250W x 150D x 500H (mm)</p>	<p>P348</p>  <p>WMA-167/SS Stainless Steel Wall Mounted 240W x 130D x 200H (mm)</p>	<p>P349</p>  <p>WMA-166/SS Stainless Steel Wall Mounted Ashtray Bin 190W x 100D x 280H (mm)</p>	<p>P350</p>  <p>ASH-175/SS Smoke Bin C/W Ground Mounted 180W x 180D x 1000H (mm)</p>
<p>P351</p>  <p>ASH-174/SS Smoke Bin C/W Ground Mounted 218W x 218D x 1005H (mm)</p>	<p>P352</p>  <p>ASH-178/SS Smoke Bin C/W Pole & Base 170W x 125D x 980H (mm)</p>	<p>P353</p>  <p>ASH-176/SS Smoke Bin C/W Ground Mounted 345W x 170D x 1200H (mm)</p>	<p>P354</p>  <p>WMA-171/SS Stainless Steel Wall Mounted Ashtray Bin 110W x 200D x 300H (mm)</p>



P355
WMA-170/SS
Stainless Steel Wall Mounted Ashtray Bin
300W x 100D x 400H (mm)



P356
WAS-1306S
Ashtray Bin & Stand
100L x 76W x 460H (mm)
Volume : 1.7 Litres



P357
WAS-1307S
Ashtray Bin & Stand
71L x 51W x 400H (mm)



P358
RPB 012
12 Liters Stainless Steel Pedal Bin
Dia 290 Dia x 450m Ht mm



P359
Stainless Steel Litter Bin C/W Pedal
RPD-080/SS (32L)
300D x 450H (mm)
RPD-081/SS (43L)
350D x 450H (mm)
RPD-082/SS (56L)
300D x 785H (mm)
RPD-046/SS (75L)
350D x 785H (mm)



P360
AS-BOWL-F
Outdoor Bin / Advertisement Bin
390D x 760H (mm)
Volume : 40 Litres



P361
ATB-165/SS
Stainless Steel Advertisement Bin
380W x 230D x 750H (mm)



P362
RECYCLE-137/SS
Pedal Recycle Bin C/W S/Steel Body & S/Steel Cover
350D x 785H (mm)



P363
MOB-104S
Outdoor Bin / Advertisement Bin
710L x 410W x 1000H (mm)
Volume : 130 Litres



P364
SRB-044/OT
SS Semi Round Bin C/W Open Top
457W x 227D x 760H (mm)



P365
RB-002S-FF
Hygiene Ashtray & Waste Bin
245D x 380H (mm)



P366
RB-102S-FF
Hygiene Ashtray & Waste Bin
210D x 300H (mm)
Volume : 5 Litres



P367
UB 22
Umbrella Bin - Powder Coated
220(D) x 575(H) mm



P368
RB-819S
Hygienic Room Bin
200L x 200W x 280H (mm)
Volume : 8.6 Litres



P369
RB-818S-13L
Hygienic Room Bin
240D x 300H (mm)
Volume : 13 Litres



P371
RAB-144/OT
S/Steel Design Waste Bin C/W Open Top
670W x 670D x 820H (mm)



P372
RB-410S
Outdoor Bin / Advertisement Bin
450D x 800H (mm)
Volume : 63 Litres



P373
LD-RAB-091/A
S/Steel Round Waste Bin C/W Ashtray Top
300D x 650H (mm)



P374
LD-RAB-013/SS
S/Steel Round Waste Bin C/W Open Top
380D x 760H (mm)



P375
LD-RFT-086/SS
S/Steel Round Waste Bin C/W Flip Top
380D x 760H (mm)



P376
LD-RAB-087/SS
S/Steel Round Waste Bin C/W 1/2 Ashtray & 1/2 Open Top
380D x 760H (mm)



P377
LD-RB-097/EX(GR)
Powder Coating Round Waste Bin (Double Layer)
225D x 270H (mm)



P378
LD-RAB-074/SS
S/Steel Round Waste Bin C/W Open Top
250D x 600H (mm)



P379
LD-RFT-085/SS
S/Steel Round Waste Bin C/W Flip Top
300D x 650H (mm)



P380
LD-DAB-089/SS
S/Steel + Print Coating Diamond Shape Waste Bin C/W Ashtray Top
310W x 260D x 650H (mm)



P381
LD-DAB-088/SS
S/Steel + Print Coating Diamond Shape Open Top Bin
310W x 260D x 650H (mm)



P382
S/Steel Rectangular Waste Bin C/W Ashtray Top
LD-RAS-090/SS
300W x 240D x 620H (mm)
LD-RAS-073/SS
400W x 300D x 760H (mm)



P383
LD-RAB-092/A
S/Steel Round Waste Bin C/W Ashtray Top
250D x 610H (mm)



P384
SS108-G
Stainless Steel Bin Round C/W Ashtray Top (Gold Electroplated)
250D x 610H (mm)



P385
SS108-B
Stainless Steel Bin Round C/W Ashtray Top (Black Electroplated)
250D x 610H (mm)



P386
SS109
Stainless Steel Bin Round C/W Ashtray Top
250D x 760H (mm)

Stainless Steel Bin

Stainless Steel Bin

P387

Room Bin Round Double Layer
225D x 265H (mm)
PB003-B
Black Powder Coated Steel Outer
PB003-SS
Stainless Steel Outer

P388

RCB-1302S-Q
Tri Quadro Recycle Bin
1600L x 400W x 800H (mm)
Volume : 47 Litres

P389

RD Quadro Recycle Bin
1520L x 380W x 800H (mm)
Volume : 47 Litres / Inner Liner

P390

RCB-1101S
Stainless Steel 3 Hole
Recycling Bin 400 x 400

P403

RCB-1303S-D
FL Duo Recycle Bin
760L x 415W x 800H (mm)
Volume : 62 Litres / Inner Liner

P404

RECYCLE-139/SS
Round Recycle Bins C/W S/Steel
Body & Powder Coating Cover
390D x 760H (mm)

P405

RECYCLE-136/SS
Round Recycle Bins C/W S/Steel
Body & Powder Coating Cover
390D x 760H (mm)

P406

RECYCLE-138/SS
Rectangular Recycle Bins
C/W S/Steel Body & Powder
Coating Cover
400W x 300D x 760H (mm)

P391

RECYCLE-129/SS
Square Recycle Bin C/W Mild Steel
Body & Stainless Steel Cover
300W x 300D x 740H (mm)

P392

RECYCLE-134/SS
Rectangular Recycle Bin C/W Stainless
Steel Body Mild Steel Cover
380W x 230D x 740H (mm)

P393

RECYCLE-127/SS
Stainless Steel Square Recycle Bin
300W x 300D x 740H (mm)

P394

RECYCLE-128/SS
Square Recycle Bin C/W Stainless
Steel Body & Mild Steel Cover
300W x 300D x 740H (mm)

P395

RECYCLE-135/SS
Rectangular Recycle Bin C/W Mild
Steel Body & Stainless Steel Cover
380W x 230D x 740H (mm)

P396

RECYCLE-129/SS
Square Recycle Bin C/W Mild Steel
Body & Stainless Steel Cover
300W x 300D x 740H (mm)

P397

RECYCLE-130/SS
Stainless Steel Round Recycle Bin
295D x 760H (mm)

P398

RECYCLE-131/SS
Round Recycle Bin C/W Stainless
Steel Body & Mild Steel Cover
295D x 760H (mm)

P399

RECYCLE-140/SS
Semi Round Recycle Bin C/W Stainless
Steel Body & Powder Coating Cover
345W x 170D x 660H (mm)

P400

RECYCLE-132/SS
Round Recycle Bins C/W Mild Steel
Body & S/Steel Cover
295D x 760H (mm)

P401

Recycle Bin With 3 Bin & Inner Liner
500L x 500W x 1000H (mm)
Volume : 65 Litres / Inner Liner

P402

RCB-1303S-T
FL Trio Recycle Bin
1140L x 415W x 800H (mm)
Volume : 62 Litres / Inner Liner

Stainless Steel Planter Pots



<p>P414</p>  <p>SB-352 SS + Wood Benches Size : 1750W x 550D x 520H (mm)</p>	<p>P415</p>  <p>SB-353 SS + Wood Benches Size : 1600W x 550D x 520H (mm)</p>	<p>P416</p>  <p>SB-350 Stainless Steel Benches Size : 1250W x 453D x 453H (mm)</p>	<p>P417</p>  <p>SB-351 Stainless Steel Benches Size : 1250W x 651D x 893H (mm)</p>
------------------------------------------------------------------------------------------------------------------------------------------------------------------------------	------------------------------------------------------------------------------------------------------------------------------------------------------------------------------	-------------------------------------------------------------------------------------------------------------------------------------------------------------------------------------	--------------------------------------------------------------------------------------------------------------------------------------------------------------------------------------

<p>P418</p>  <p>SS + Powder Coating Benches SB-360 Size : 1250mm(W) x 665mm(D) x 910mm(H) SB-361 Size : 1550mm(W) x 565mm(D) x 910mm(H) SB-362 Size : 1850mm(W) x 665mm(D) x 910mm(H) Various available powder coated colours Black Blue Red Green Yellow Biege</p>	<p>P419</p>  <p>MS + Powder Coating Benches SB-369 Size : 1250mm(W) x 565mm(D) x 540mm(H) SB-370 Size : 1550mm(W) x 565mm(D) x 540mm(H) SB-371 Size : 1850mm(W) x 565mm(D) x 540mm(H) Various available powder coated colours Black Blue Red Green Yellow Biege</p>	<p>P420</p>  <p>SS + Powder Coating Benches SB-366 Size : 1250mm(W) x 665mm(D) x 910mm(H) SB-367 Size : 1550mm(W) x 665mm(D) x 910mm(H) SB-368 Size : 1850mm(W) x 665mm(D) x 910mm(H) Various available powder coated colours Black Blue Red Green Yellow Biege</p>
-----------------------------------------------------------------------------------------------------------------------------------------------------------------------------------------------------------------------------------------------------------------------------------------------------------------------------------------------------------------------------------------------------------	-----------------------------------------------------------------------------------------------------------------------------------------------------------------------------------------------------------------------------------------------------------------------------------------------------------------------------------------------------------------------------------------------------------	------------------------------------------------------------------------------------------------------------------------------------------------------------------------------------------------------------------------------------------------------------------------------------------------------------------------------------------------------------------------------------------------------------

<p>P421</p>  <p>MS + Powder Coating Benches SB-363 Size : 1250mm(W) x 665mm(D) x 910mm(H) SB-364 Size : 1550mm(W) x 665mm(D) x 910mm(H) SB-365 Size : 1850mm(W) x 665mm(D) x 910mm(H) Various available powder coated colours Black Blue Red Green Yellow Biege</p>	<p>P422</p>  <p>MS + Powder Coating Benches SB-357 Size : 1250mm(W) x 465mm(D) x 625mm(H) SB-358 Size : 1550mm(W) x 465mm(D) x 625mm(H) SB-359 Size : 1850mm(W) x 465mm(D) x 625mm(H) Various available powder coated colours Black Blue Red Green Yellow Biege</p>	<p>P423</p>  <p>SS + Powder Coating Benches SB-354 Size : 1250mm(W) x 665mm(D) x 910mm(H) SB-355 Size : 1550mm(W) x 665mm(D) x 910mm(H) SB-356 Size : 1850mm(W) x 665mm(D) x 910mm(H) Various available powder coated colours Black Blue Red Green Yellow Biege</p>
-------------------------------------------------------------------------------------------------------------------------------------------------------------------------------------------------------------------------------------------------------------------------------------------------------------------------------------------------------------------------------------------------------------	-------------------------------------------------------------------------------------------------------------------------------------------------------------------------------------------------------------------------------------------------------------------------------------------------------------------------------------------------------------------------------------------------------------	--------------------------------------------------------------------------------------------------------------------------------------------------------------------------------------------------------------------------------------------------------------------------------------------------------------------------------------------------------------------------------------------------------------

<p>P424</p>  <p>SBL-385-H / SBL-385-M Stainless Steel Bollard 170D x 1300H (mm)</p>	<p>P425</p>  <p>SBL-373-H / SBL-373-M Stainless Steel Bollard 150D x 1000H (mm)</p>	<p>P426</p>  <p>SBL-374-H / SBL-374-M Stainless Steel Bollard 100D x 1000H (mm)</p>	<p>P427</p>  <p>Stainless Steel Bollard SBL-380-H / SBL-380-M 100D x 1000H (mm) SBL-381-H / SBL-381-M 150D x 1000H (mm)</p>
<p>P428</p>  <p>SBL-382-H / SBL-382-M Stainless Steel Bollard 200W x 100D x 1000H (mm)</p>	<p>P429</p>  <p>SBL-384-H / SBL-384-M Stainless Steel Bollard 150W x 150D x 1200H (mm)</p>	<p>P430</p>  <p>SBL-372-H / SBL-372-M Stainless Steel Bollard 220W x 110D x 1000H (mm)</p>	<p>P431</p>  <p>Stainless Steel Bollard SBL-378-H / SBL-378-M 100D x 1000H (mm) SBL-379-H / SBL-379-M 150D x 1000H (mm)</p>
<p>P432</p>  <p>Stainless Steel Bollard SBL-383-H / SBL-383-M Top : 300D (mm) Bottom : 100D x 600H (mm)</p>	<p>P433</p>  <p>SBL-377-H / SBL-377-M Stainless Steel Bollard 150 x 1000H (mm)</p>	<p>P434</p>  <p>Stainless Steel Bollard SBL-375-H / SBL-375-M 330W x 150D x 1000mm(H) SBL-376-H / SBL-376-M 200W x 100D x 1000H (mm)</p>	<p>P435</p>  <p>Metal Bollard Mild Steel Complete With Reflective Sticker Size A : 100 mm Dia x 840mm Ht size B : 160 mm Dia x 840mm Ht Option : With or without Hook</p>
<p>P436</p>  <p>Ajustable Parking Pole (Mild Steel) 80mm Dia x 820 mm Ht (Round Pole) 65mm x 65mm x 820 mm Ht (Square Pole) Base : 180mm x 200mm Features : With Lock Bracket</p>	<p>P437</p>  <p>PU Bollard 80mm Dia x 800Ht</p>	<p>P438</p>  <p>Directional Bollard 335mm x 335mm x 960mm Ht Material : HDPE</p>	<p>P439</p>  <p>FRP Bollard (Fiber Reinforced Plastic) 195 mm (Top) x 917mm Ht Base Diameter : 186mm</p>



P440



QPT+102/SS
S/Steel Self Retractable Belt Q-Up Stand
FRQ-1211/SS
S/Steel Frame For Belt Retractable Belt Q-Up Stand (Frame Only)

P441



QS010-Red
QS024-Black
QS012-Red
QS022-Black

Stainless Steel Q-Up Stand C/W Stackable & Retractable Belt
360D Base x 63D Pole x 910H (mm)
Belt Length : 1900mm = 6ft
Body: Stainless Steel, Stainless Steel Black-Coated

P442



QS014-Red
QS015-Black
QS016-Blue
QS017-White
QS018-Yellow
QS019-Orange
QS020-Purple
QS021-Green
QS008-Red
QS009-Black

Stainless Steel Q-Up Stand C/W Retractable Belt
320D Base x 63D Pole x 910H (mm)
Belt Length : 1900mm = 6ft
Body: Stainless Steel, Stainless Steel Black-Coated, Stainless Steel Gold-Electroplated

P443



A3 Sign Holder For Retractable Barrier Posts Landscape

P444



QUS-104ss
Stainless Steel Q-Up Stand
Pole: 50mm Base: 320mm
Height: 1010mm

P445



QS003-Blue
QS002-Red
QS102-B-Black
QS102-G-Gold

Q-Up Stand Velvet Rope 5ft

P446



QUS-111/SS
Stainless Steel Q-Up Stand
Pole: 50mm Base: 320mm
Height: 970mm

P447



QS001-Stainless Steel
QS001-G-Gold-Electroplated
Stainless Steel Q-Up Stand Velvet Rope Type
320D Base x 50D Pole x 1015H (mm)

P448



QUS-100/SS
Stainless Steel Q-Up Stand
Pole : 63.5mm Base : 320mm
Height : 920mm

P449



SBS-022/SS
Stainless Steel Sign Board Stand
Frame Size : A4, A3 or Custom Design Size
Pole: 50mm Base: 300mm
Height: 1355mm / 1305mm

P450



Stainless Steel Poster Sign Board Stand
600 x 800 x 1200 (mm)

P451



SBS-057/SS
Stainless Steel Sign Board Stand
Frame Size : 305mm x 425mm
Height : 1080mm

P452



QS007
Stainless Steel A3 Menu Stand (Frame 360° & Height 850mm x 1350mm Adjustable)
375D Base x 28D Pole (mm)

P453



Wall Mounted Self Retractable Belt Head C/W Wall Mounted Bracket
WMB-201
Length Of Belt : 2 Meter
Head Size : 75W X 100D X 140H (mm)
WMB-202
Length Of Belt : 5 Meter
Head Size : 95W (mm)

P454



Double Belt Q Stand



Wringer Mop Bucket House Keeping Trolley

P455

SBT-349
Single Wringer Bucket C/W Trolley & Basket (Side Press)
Size : 340W x 460D x 945H (mm)

P456

NSB-22
Single Wringer Bucket
Colour : Yellow, Blue, Green, Red
Material : PP
Capacity : 22 Litres
Size: 312(L) x 396(W) x 750(H)

P457

NSB-29
Single Wringer Bucket
Colour : Yellow, Blue
Material : PP
Capacity : 29 Ltres
Size: 370(L) x 505(W) x 790(H)

P458

SWB-313
Single Wringer Bucket C/W Trolley + Tool Container + Extra Bucket Below Wringer
Size : 920W x 515D x 930H (mm)

P467

JC-309
Janitor Cart C/W Cover
1130W x 515D x 980H (mm)

P468

JC-311
Multifunction Janitor Cart
1190W x 515D x 1120H (mm)

P469

JC-314
Janitor Cart C/W Cover
1300W x 550D x 1000H (mm)

P470

JC-315
Janitor Cart C/W Wringer Bucket
1300W x 550D x 1000H (mm)

P459

SWB-312
Single Wringer Bucket C/W Extra Bucket Below Wringer
Size : 630W x 480D x 790H (mm)

P460

SWB-387(YE)
Single Wringer Bucket (Down Press)
Size : 640W x 380D x 800H (mm)

P461

SWB-347
Single Wringer Bucket (Side Press)
Size : 430W x 280D x 465H (mm)

P462

Single Wringer Bucket (Down Press)

47

SMT-150
Housekeeping Trolley (High Security Design) C/With Down press wringer bucket (2 x 15L)
Contains two large 35 litre buckets
Contains two small 10 litre buckets
110 litre waste yellow bag
Lockable cabinet on both sides for safety
Roll top lid/Cover for extra security
Dimensions : 1350 L x 590 W x 1220 (H) mm
Holds up to 150kgs in weight

P472

ECT-900/SS
Stainless Steel Escort Cart
1200(W) x 450(L) x 1040(H)mm

P473

JC-310
Multifunction Janitor Cart
1260W x 740D x 1105H (mm)

P474

Stainless Steel Maid Trolley
MDT-206/SS (Big)
1486W x 559D x 1168H (mm)
MDT-204/SS (Small)
1310W x 559D x 886H (mm)

P463

DBPF-343
Double Bucket C/W Plastic Frame (Down Press wringer)
790 W x 450 D x 865 Ht mm
Capacity : 2 x 23ltr

P464

Double Bucket C/W Plastic Frame (Down Press Wringer)
850W x 440 D x 920 Ht mm
Capacity : 2 x 17ltr

P465

WWB-546
Window Washer Bucket
Size : 510W x 270D x 340H (mm)

P466

Wringer Only (Down /Side Press)

P475

PMT-509/P
Maid Trolley
1480W x 550D x 1000H (mm)

P476

MDT-205/EX
Powder Coated Maid Trolley
1400 x 460 x 1110 (H) mm

P477

PMT-510/P
Maid Trolley C/W Door
1540W x 540D x 1285H (mm)

P478

MDT-206/EX(GR)
Powder Coating Maid Trolley
1486W x 559D x 1168H (mm)

Trolley & Housekeeping Equipment

<p>P479</p>  <p>SLT 505/SS Stainless Steel Soil Linen Trolley 920 x 680 x 800 (H)mm</p>	<p>P480</p>  <p>Plastic XLinen Trolley 710 mm X 660 X 950(H) mm Load Capacity : 100 kgs</p>	<p>P481</p>  <p>X2T-506/Chrome Chrome Steel X-2 Trolley Size : 670W x 600D x 1050H (mm)</p>	
<p>P482</p>  <p>CSL-501/SS Stainless Steel Collection & Sorting Of Soiled Linen Trolley Size : 1120W x 530D x 950H (mm)</p>	<p>P483</p>  <p>SLT-511/SS Stainless Steel X-2 Trolley Size : 800W x 520D x 880H (mm)</p>	<p>P484</p>  <p>FGLT-513/FG Fibreglass Laundry Trolley With Handle *Come With 100mm (Dia) Rubber Wheels Size : 960W x 745D x 780H (mm)</p>	
<p>P485</p>  <p>FGLT-513/FG Fibreglass Laundry Trolley With Handle *Come With 100mm (Dia) Rubber Wheel Size : 1500W x 810D x 795H (mm)</p>	<p>P486</p>  <p>SLT 500 Powder Coated Clean Linen Trolley Size : 720 x 535 x 1800 Ht mm</p>	<p>P487</p>  <p>SLT 512/SS Foldable Stainless Steel Soil Linen Trolley Size : 720 x 535 x 1800 Ht mm</p>	
<p>P488</p>  <p>Laundry Trolley (Solid Wall) Model :LT-1014 Size : 1100W x 800D x 785H (mm) Capacity : 405 Litres Stacking : 660mm</p>	<p>P489</p>  <p>Storage Container 1013 Model :SC-1013 Size : 1100W x 800D x 690H (mm) Capacity : 405 Litres Stacking : 660mm</p>	<p>P490</p>  <p>Storage Container 1011 Model : SC - 1011 Size : 1100W x 800D x 690H (mm) Capacity : 405 Litres Stacking : 660mm</p>	<p>P491</p>  <p>Laundry Trolley Model :LT-1012 Size : 1100W x 800D x 785H (mm) Capacity : 405 Litres Stacking : 660mm</p>

Baggage Trolley

<p>P492</p>  <p>LD-BCT-417/GP Crown Birdcage Cart *Come With Gold Plated And 200mm (Dia) Gold Plated Pneumatic Wheels Size : 1150W x 700D x 1950H (mm)</p>	<p>P493</p>  <p>LD-BCT-413/SS Stainless Steel Birdcage Styling Cart (Hairline Finish) *Come With 200mm (Dia) Pneumatic Wheels Size : 1140W x 670D x 1900H (mm)</p>	<p>P494</p>  <p>LD-BCT-412/SS Stainless Steel Birdcage Styling Cart (Hairline Finish) *Come With 200mm (Dia) Pneumatic Wheels Size : 1140W x 670D x 1900H (mm)</p>
<p>P495</p>  <p>LD-BCT-411/SS Stainless Steel Birdcage Cart *Come With 150mm (Dia) Non Marking Wheels Size : 1050W x 610D x 1860H (mm)</p>	<p>P496</p>  <p>LD-BGT-416/SS Stainless Steel Baggage Trolley *Come With 150mm (Dia) Non Marking Wheels Size : 1050W x 500D x 1780H (mm)</p>	<p>P497</p>  <p>BBT-403/SS Stainless Steel Bell Boy Hand Truck C/W Carpet Size : 400W x 630D x 1160H (mm)</p>
<p>P498</p>  <p>LD-BBT-414/SS Stainless Steel Bell Boy Trolley *Come With 200mm (Dia) Pneumatic Wheels Size : 500W x 400D x 1220H (mm)</p>	<p>P499</p>  <p>BQC-405/SS Stainless Steel Banquet Chair Trolley Size : 530W x 610D x 1170H (mm)</p>	<p>P500</p>  <p>BBT-402/SS Stainless Steel Bell Boy Hand Truck W/O Carpet Size : 400W x 630D x 1160H (mm)</p>

Trolley Plat Front Trolley & Umbrella Stand

<p>P501</p>  <p>2TT-1104/SS Stainless Steel 2 Tiers Trolley Size : 800W x 500D x 860H (mm)</p>	<p>P502</p>  <p>3TT-1102/SS Stainless Steel 3 Tiers Trolley Size : 800W x 500D x 860H (mm)</p>	<p>P503</p>  <p>2TT-1107/SS Stainless Steel 2 Tiers Trolley C/W Hanging Bin Size : 800W x 500D x 860H (mm)</p>	<p>P504</p>  <p>3TT-1108/SS Stainless Steel 3 Tiers Trolley C/W Hanging Bin Size : 800W x 500D x 860H (mm)</p>
<p>P505</p>  <p>3 Tiers Utilities Cart 3UC-603 (Small) Size : 845W x 430D x 950H (mm) 3UC-601 (Large) Size : 1020W x 500D x 960H (mm) Option : Tableware Collection Tray</p>	<p>P506</p>  <p>3 Tiers Cart C/W Bucket Size : 800 x 500 x 860 (mm)</p>	<p>P507</p>  <p>3 Shelf 2 Handle Trolley Material : Powder Coated Metal A. Load Capacity : 150kgs Size : 480 x 740 x 905 Ht(mm) Weight : 19kgs, Castor wheel : 4" Dia B. Load Capacity : 300kgs Size : 590 x 890 x 965 Ht (mm) Weight : 31kgs, Castor wheel : 5" Dia</p>	<p>P508</p>  <p>3 Tiers Utilities Cart C/W Buckets 3UC-604 (Small) Size : 1090W x 430D x 950H (mm) Note : Collection Tray Not Included 3UC-602 (Large) Size : 1300W x 500D x 960H (mm) Note : Collection Tray Not Included Option : Tableware Collection Tray</p>
<p>P509</p>  <p>Shopping Trolley SH 100A (100 L) 520 W x 860 L x 955 Ht (mm) SH 125A (125 L) 560 W x 890 L x 1030 Ht (mm) SH 150A (150 L) 580 W x 1010 L x 1020 Ht (mm) Colour: Silver & Red</p>	<p>P510</p>  <p>2 Shelf 2 Handle Trolley Material : Powder Coated Metal A. Load Capacity : 150kgs Size : 480 x 740 x 895 Ht(mm) Weight : 19kgs, Castor wheel : 4" Dia B. Load Capacity : 300kgs Size : 590 x 890 x 945 Ht (mm) Weight : 31kgs, Castor wheel : 5" Dia</p>	<p>P511</p>  <p>Plastic Hand Truck 150kg / 300kg Built for long service-idea for office, school, factory, warehouse and in-store use. Foldable handle with foot operated release bar. Attached with 2 fixed and 2 swivel rubber castor wheels. Size A. Load Capacity : 300kgs Platform size mm 610 x 910 Size B. Load Capacity : 150kgs Platform size mm 480 x 720</p>	<p>P512</p>  <p>PE-2T-1008/300 Pe-2 Tiers Trolley Size : 600W x 900D x 1000H (mm) Capacity : 300kg</p>
<p>P513</p>  <p>PE-2T-1008/300 Pe-2 Tiers Trolley Size : 600W x 900D x 1000H (mm) Capacity : 300KG</p>	<p>P514</p>  <p>3UC-606 3 Tiers Utilities Cart C/W Bucket Note : Collection Tray Not Included SIZE : 1395W x 525D x 940H (mm) Option : Tableware Collection Tray</p>	<p>P515</p>  <p>3 Tiers Utilities Cart C/W buckets Size: 1390 x 525 x 945 (mm)</p>	<p>P516</p>  <p>3 Tiers Utilities Cart with 3 side Panel Size : 1390 x 525 x 940 (mm)</p>
<p>P517</p>  <p>Collecting Bucket (Big) For 3 tier Utilities Cart Size : 330 x 240 x 560mm Ht</p>	<p>P518</p>  <p>Collecting Bucket (Small) For 3 tier Utilities Cart Size : 330 x 230 x 180 mm Ht</p>	<p>P519</p>  <p>Collecting Tray For 3 tier Utilities Cart Size : 530 x 380 x 150 mm Ht</p>	<p>P520</p>  <p>Carry Caddy (Tools Basket) Size : 385 x 335 x 170 Ht mm</p>

<p>P521</p>  <p>Pe Platform Trolley PEPT-1004/150 (Small) Size : 500W x 700D x 730H (mm) Capacity : 150KG PEPT-1005/300 (Large) Size : 600W x 900D x 860H (mm) Capacity : 300KG PEPT-1006/450 (Extra Large) Size : 700W x 1100D x 910H (mm) Capacity : 450KG</p>	<p>P522</p>  <p>Stainless Steel Platform Trolley Size : 800 x 600 x 860 (mm)</p>	<p>P523</p>  <p>LD-PFT-1003/SS Stainless Steel Platform Trolley C/W Foldable Handle And 127mm Dia Non Marking Wheels Size : 900W x 610D x 960H (mm)</p>	
<p>P524</p>  <p>SWT 500 Power Coated Work Tainer 1080 L x 790 W x 1690 Ht (mm) Load Capacity: 500 kgs, Colour: Beige</p>	<p>P525</p>  <p>UMS-601/SS Stainless Steel Umbrella Stand Size : 635W x 360D x 800H (mm)</p>	<p>P526</p>  <p>Umbrella Lock Stand UMS-12 (12 Lock) 560(L) x 300(W) x 800(H) mm UMS-18 (18 Lock) 560(L) x 450(W) x 800(H) mm</p>	
<p>P527</p>  <p>Stainless Steel Clothes Rack Size : 750 x 1230 x 1670 (mm)</p>	<p>P528</p>  <p>Stainless Steel Clothes Rack Size : 1530 x 850 x 1775 (mm)</p>	<p>P529</p>  <p>Stainless Steel Clothes Rack Size : 2005 x 860 x 1775 (mm)</p>	
<p>P530</p>  <p>LHT-300/SS Stainless Steel Linen Hanging Trolley Size : 1219W x 406D x 1828H (mm)</p>	<p>P531</p>  <p>LD-LHT-301/SS Stainless Steel Linen Hanging Trolley C/W Bottom Basket Compartment Size : 1220W x 545D x 1700H (mm)</p>	<p>P532</p>  <p>Stainless Steel Clothes Rack Size: 900 x 460 x 1200 (mm)</p>	<p>P533</p>  <p>Stainless Steel Clothes Rack Size : 1200 x 580 x 1200 (mm)</p>

Keep the Dirts Where It Belongs, Durable & Reliable



Commercial Floor Matting

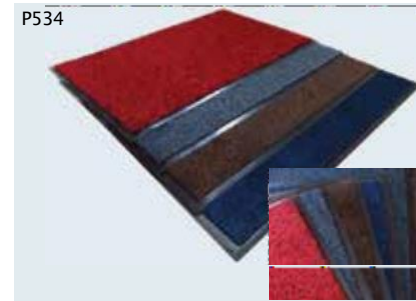

Laundry Mat (Dust Control)

Iron Horse Mat features Solution-dyed nylon, which resists fading and bleaching. The crush-resistant pile traps dirt better, and extends the performance life of the mat. The nitrile rubber backing is skid-resistant and resists oil and grease.

Size	Red	Blue	Brown	Grey
2ft x 3ft	FM011-RE	FM011-BL	FM011-BR	FM011-GY
3ft x 5ft	FM012-RE	FM012-BL	FM012-BR	FM012-GY
4ft x 6ft	FM013-RE	FM013-BL	FM013-BR	FM013-GY
4ft x 8ft	FM014-RE	FM014-BL	FM014-BR	FM014-GY
4ft x 12ft	FM015-RE	FM015-BL	FM015-BR	FM015-GY



3A Hygiene Coil Mat

- 3A Coil Mat / The Dirt Absorbing Mats / Dirt Scraper Floor Mat
- Resilient Vinyl loops trap & hide dirt
- Minimizes tracking & protects floors and carpets
- Foam backing provides added comfort while holding moisture and dirt off floor

Common Application:

Office Entrance, Main Entrance, Inside Building Entrances, Public Areas, Interior Walkways, Hallway Areas, Elevators, Hotels Entrances and Factories Entrances

Roll Sizes : 1.2M x 9M & 1.2M x 18M

Colours : Red, Blue, Green, Grey, Brown, Black & Yellow

Custom Made Design Available



Tough Rib Mat

- Traditional high performance indoor / outdoor ribbed carpet mat
- Bevel design provides aggressive walk-off performance
- Tough rib mat will wick to soak up liquids & water from your shoes, leaving your floor dry and safe from slips
- Non-staining, non-slip vinyl backing
- These mats have excellent water absorption and dirt concealing characteristics
- Easy to clean - vacuum, sweep or hose down

Common Application:

Main Entrance, Inside Building Entrance, Hallway Areas, Interior Walkways, Toilet Entrance, Kitchen Entrance, Locker Areas, Swimming Pools Surrounds, Bar Counter Walkways, Elevators, Boats

Roll Sizes:

91CM x 18M

121CM x 18M

181CM x 18M

Standard Size: 91cm x 18m (x3)

Colours: Red, Blue, Green, Grey, Brown, Black



Welcome Mat

Mat Type	Size	Red	Blue
Laundry Mat	3ft x 5ft	FM011-RE	FM011-BL
	4ft x 6ft	FM012-RE	FM012-BL
Coil Mat	3ft x 5ft	FM121-RE	FM121-BL
	4ft x 6ft	FM122-RE	FM122-BL



EH4000 Dirt & Water Trapper Mats

- Newest High Technology dual fiber carpet - type matting, offers unique 2 in 1 performance of excellent water removal & dirt trapping
- Long lasting & resists crushing staining, specially designed for heavy traffic areas

Roll Sizes : 90CM x 18M, 120CM x 18M, 180CM x 18M

Colours : Red, Grey, Brown, Black

Custom Made Design available



Customize Worded & Design
Available For : 3A Hygiene Coil Mat, Tough Rib Mat, EH 4000 & 3M Coil Matting

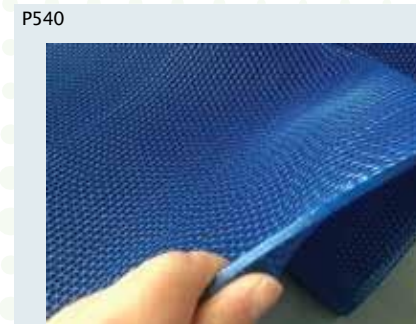

3M Entrap

3M Entrap / 3M Entrap Wet Area Matting / 3M Entrap Mat / 3M Entrap 3200 - Roll Form ? Custom Floor Mats In Sizes

Features Of The Mat :

- 3M Entrap mat is UV stable and resist fungus and mildew.
- Its open construction allows liquids to run easily through the mat.
- The product provides a slip-resistant, comfortable walking surface for barefoot traffic and requires only simple maintenance.
- The 3M Entrap mat's open design helps protect floors by helping them to dry more quickly while keeping the walking surface free of moisture.

Common Application : Locker rooms, Around Saunas, Whirlpools, Shower Areas, Swimming Pools, Bath Rooms, Freezer Rooms Or Wet And Slippery Areas.

Roll Size : 1.2m x 15m

Colours : Red, Blue, Grey



Clean Grip Mat (Safety Scrape Mat)

- It Is The Perfect Non Slip Mat For Wet & Greasy Food Service Or Industrial Areas.
- Aggressive nitrile rubber gripprunner.
- Raised gripper surface pattern provides excellent traction in slippery areas.
- Durable nitrile rubber construction for oil and general chemicals resistance.

Common Application : Kitchens, Locker Rooms, Restaurants, Production Areas, Outside Entrances, Behind Lounge Counters & Bars, Slippery Inclines And Grocery Store Produce Areas.

Standard Size : 90cm x 150cm (x 5)

Colour : Black



3M Enhance Matting

- 3M Enhance Matting / 3M Nomad Carpet Matting 4000
- Roll Form / Custom Floor Mat In Sizes, Worded & Rubber Edging
- 3M Nomad carpet matting 4000 are ingenious designs that keep dirt and moisture within the mats while ensuring a dry and comfortable interior.

Features Of Mat

- Features - laden and durable, it offers the most effective and economical way to protect hard floors and carpets to keep the interior clean and safe
- Its unique combination of large and small diameter fibers provides superior dirt and water removal
- It is fire-resistant and can help prevent fire caused by cigarette ends

Common Application:

High Traffic Entryway - Kitchen Entrance
Main Entrance - Locker Areas
Inside Building Entrance - Swimming Pools Surrounds
Hallway Areas - Bar Counter Walkways
Interior Walkways - Elevators

Toilet Entrance

Roll Size : 91cm x 18m 120cm x 18m 181cm x 18m

Colours : Red, Grey, Brown, Black

Custom design available

Commercial Floor Matting

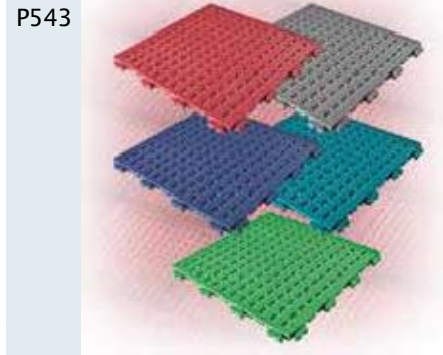

P543
AS 403
Anti Slip Mat, Size : 1 x 1
Colour : Navy Blue, Green, Meroon, Brown & Gray
50 pcs/carton

Slideproof rug is hard, durable and non-slip. Modular interlocking anti slip mat suitable for any size areas.
- Prevent slips and falls with its-special mat which allows maximum drainage of liquids to keep surface clean and dry.
- Easy to clean and maintain.
- Common Application : Washroom, Kitchen, Surrounding Of Swimming Pools, Locker Rooms, Leisure centres And Any Wet Areas.

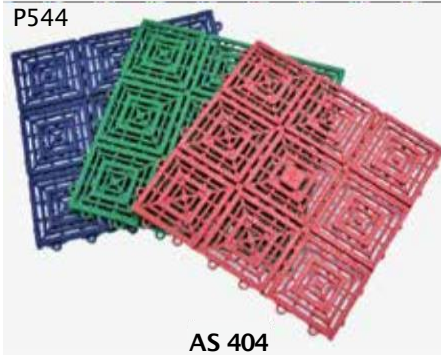

P544
AS 404
Anti Slip Mat, Size : 1 x 1
Colour : Navy Blue, Green, Meroon, Brown & Gray
50 pcs/carton



P545
AS 405
Anti Slip Mat, Size : 1 x 1
Colour : Navy Blue, Green, Meroon & Gray
50 pcs/carton



P546
SW 35 Kitchen Mat (Safe Walk Mat)
It is a durable heavy duty rubber mat designed to last longer than other mats. Anti-fatigue properties help prevent aches & pains from extending standing.
- Economical drainage mat that offers superior traction and good resistance to oil and fats.
- Raised base promotes movement of liquids resulting in a safer work environment.
- Easy to handle, clean and maintain.
Common Application : Kitchens, Food Processing, Bar, Cafeteria, Industrial Work Stations, Dishwashing Areas, Assembly Lines.
Area Subject To Liquids, Fats, Grease, Oil, Long Hour Standing Etc.
Standard Size : 90cm x 150cm x 12mm - (SW35)
Colour : Black



P547
SW 99 Interlocking Kitchen Mat / Safe Walk Mat
It is a durable heavy duty rubber mat designed to last longer than other mats. Anti-fatigue properties help prevent aches & pains from extending standing.
- Economical drainage mat that offers superior traction and good resistance to oil and fats.
- Raised base promotes movement of liquids resulting in a safer work environment.
- Easy to handle, clean and maintain.
Common Application : Kitchens, Food Processing, Bar, Cafeteria, Industrial Work Stations, Dishwashing Areas, Assembly Lines, Area Subject To Liquids, Fats, Grease, Oil, Long Hour Standing Etc.
Interlocking Size : 90cm x 90cm x 9.5mm - (SW99)
Colour : Black

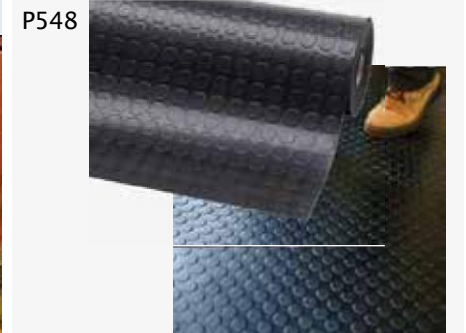

P548
RS22 / RS100 / RS120 Rubber Stud Mat
- Rubber Stud Mat (Coin Flooring) Round Stud Rubber Flooring
- Rubber Studded Tiles
- Standard Size Roll Form
- Rubber stud mat (coin flooring) makes an ideal industrial or domestic floor covering.
- Made from natural rubber and has good water resistance property and resist to abrasion/tear.
- Good for flooring protection with relatively low cost.
- Long lasting & durable.
Common Application : Gym Floor, Laboratories, Bars, Elevators and Walkways, Hallways, Staircase, Corridors, Subway, High Traffic Areas, Industrial & Automation Pathway, Heavy Duty Work Place, Wet & Dry Area, Production Floor Slip Coverage, Skipping & Packaging Areas, etc.
Standard Size : 2 x 2 Per Pc - (RS22)
Colour : Black



P549
Diamond Plate Rubber Flooring
- The non-directional diamond plate pattern gives this matting a non-slip surface that is still easy to mop / clean and wick trap dirt.
- Diamond plate matting is extremely durable and makes an ideal walkway to heavy foot traffic.
- Diamond plate surface pattern adds extra traction.
Common Application : commercial retail entrances and walkways, garages, pet carriers, corridors with heavy traffic, warehouses, workshop, track flooring, vans, boats, load areas and factories etc.
Roll Size : 1.2m x 10m x 3mm
Colour : Black



P550
3M Safety Walk Tape - 510 / 610
3M Safety-Walk-Slip-Resistant Conformable Tapes And Treads - 510 / 610
- For irregular or contoured surfaces in light to heavy shoe-traffic areas.
- Mineral-coated, high friction slip-resistant surface.
- Aluminium backing (510 only) conforms to corners, curves, and irregular surfaces.
- Aggressive, high performance adhesive forms an excellent bond for a secure hold.
Common Applications:
Platforms, Loading Docks, Ladders, Ramps, Stairs / Steps Diamond Plated, Irregular or Contoured Walking Surfaces
Sizes : 2 x 6 (2 rolls / ctn) & 6 x 6 (1 roll / ctn)
Colours : Black - 510 - With Aluminium Backing
Black - 610 - Without Aluminium Backing



P551
Car Mat DIY
- ECO-4 Ecoformat DIY Set Car Mat (Magic Grip Backing)
- Ecoformat has been tested in accordance with VDA standard & specifications (German Association of the Automotive industry)
- Specifications are incorporate high-temperature hot melt technology to make strong combination of rubber on the bottom, make it difficult to separate & without pungent smell of glue.
- Its Free from specific Hazardous chemicals.
- Non toxic heavy metals
- No bad odour
- Not release formaldehyde
- Not release VOCs
- Not release VOCs under high temperature ECO-4 Ecoformat DIY Set Car Mat (Magic Grip Backing)
- Ecoformat has been tested in accordance with VDA standard & specifications (German Association of the Automotive industry)
- Specifications are incorporate high-temperature hot melt technology to make strong combination of rubber on the bottom, make it difficult to separate & without pungent smell of glue.
- Its Free from specific Hazardous chemicals.
- Non toxic heavy metals
- No bad odour
- Not release formaldehyde
- Not release VOCs
- Not release VOCs under high temperature

Commercial Floor Matting



Natural Rubber (Rough Surface)			
Thickness	Width (mtr)	Length Per Roll (mtr)	Weight Per Roll (kg)
1.5mm (1/16")	1	16	50
3mm (1/8")	1	8	50
5mm (3/16")	1	5.4	50
6mm (28")	1	4.3	50
8mm (5/16")	1	3.5	50
8mm (5/16")	1	7	100
9.5mm (38")	1	5.4	100
12mm (1/2")	1	4.3	100
15mm (5/8")	1	4.2	120
19mm/20mm (68")	1	2.8	100
19mm/20mm (68")	1	4.2	150
25mm (1")	1	2.2	100

Natural Rubber (Smooth Surface)			
Thickness	Width (mtr)	Length Per Roll (mtr)	Weight Per Roll (kg)
1.0mm	1	20	50
1.5mm (1/16")	1	16	50
6mm (28")	1	4.3	50



P555
ESD Control Table Mat
- ESD control table mat, which is made of two layer (Static - Dissipate & Conductive), will protect the hazard of static electricity having origin in maintenance electric potential difference at zero volt between one's body and a mat as well as device sensitive to static electricity.
- These anti static mat can be layed on floor or table top. These mats are specially manufactured with controlled low resistance.
Common Application : Electronic Manufacturing And Repairing, Soldering, Clean Room Environment, Scientific Establishments, Aerospace, Hospitals, Medical Assembly Etc.
Roll Size : 1m x 10m x 2mm / roll & 1.2m x 10m x 2mm / roll
Colour : Green + Black



P553
Tuff Spun Mat (Anti Fatigue Mat) - Ecoformat
Tuff spun closed-cell PVC sponge optimizes economical comfort and fatigue relief.
- Available in pebbled surface, Tuff Spun helps reduce stress to paws, hips and knee joints.
- Beveled edges help reduce tripping.
- Amust for worker comfort and safety
- This anti-fatigue mat increases productivity throughout the workplace.
- Reduces underfoot noise and protects items accidentally dropped from damage.
Common Application : Factories, Work Station, Finishing / Assembly Station, Cafeteria Station, Laboratories, Gym, Packing Areas, Mailrooms and Processing Plants Where Employees Are Required To Stand For Prolonged Periods Of Time At Their Work.
Roll Size : 1.2m x 18m
Thickness : 9.5mm
Colour : Black (Pebbled Design)



P554
Anti Fatigue / Anti Static Mats ESD410
ESD anti fatigue mat is suitable for assembly lines and other workplaces to reduce individual worker's fatigue from long-standing jobs.
- Durable, slip-resistant surface with diamond plate pattern texture and easy to clean, resists most common fluids and chemicals. Black with high-visibility yellow stripe border.
- Suitable for anti-static area (especially the ground) the transformation of the economy a simple and effective anti-static anti-fatigue measures.
Common Application : Ideal For Use In Heavy-Duty Environments, Electronic Manufacturing, Pharmaceutical Plants, Clean Rooms, Fiber Optics, Electronic Assembly, Electronic Warehousing, Circuit Assembly, Aerospace And Hospitals.
Standard Size : 60cm x 90cm (2 x 3)
Thickness : 12.5mm
Colour : Black + yellow



P556
Sticky Mat
Sticky Mat Clean Room Sticky Mat Clean Room Floor Mats
- Standard Size Clean Room Sticky Mat
- Clean room sticky mats are made of polyethylene film. They are used to trap impurities in areas that require dust and dirt control for clean room environment.
- The fast, convenient, reliable way to clean shoe soles before entering the clean room.
- Each mat has 30 layers of film laminated together in a stack for easy removal.
- These clean room sticky mats help maintain a clean dust-free environment.
Common Application : Clean Room Or A Sanitary-Sensitive Room And Also Not Limited To Any Areas Required High Sanitary Environment, I.e, Labs, Office Entrance, Dust / Dirt Free Environment Production Entrance Etc.
Standard Sizes : 24" x 36" (30 sheets x 8 mats) per carton
26" x 45" (30 sheets x 8 mats) per carton
Colour : Blue



P557
Chair Mat - Studded
- Studded chair mats are ergonomic aids and maximize efficiency in your workspace.
- They also enable you to easily and smoothly roll from task to task in your workspace.
- Studded back designed to achieve a strong gripping without piercing or damaging your carpet.
Common Area : Carpet Surface
Standard Size : 45" x 55" x 3mm (Lipped) - (CM4553-N)
Roll Form : 1.2m x 12m x 3mm - (CM4553-R)
Colour : Clear Transparent
Chair Mat - Non Studded
- Non studded chair mat provides maximum durability to protect flooring from caster wear, spill or heavy traffic.
- Smooth back for hard floor application.
- Functional, Light pebbled surface resists wear and preserves the mobility factor.
Common Application : Vinyl Tiles, Laminates, Parquet, Tiles, hardwood, concrete and all hard floors.
Standard Size : 45" x 55" x 3mm (Lipped) - (CM4553-P)
Colour : Clear Transparent

We clean. A lot.



Colour Round Mop Full Colour Round Mop 300gm (Cut End)



Semi Colour Round Mop 300gms (Cut End)



Cotton Circular Mop C/W Colour Ribbon 300gm (Loop End)

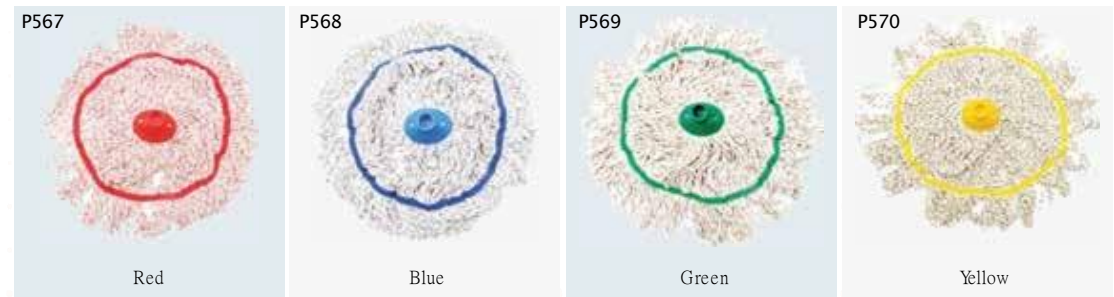

Full Colour Circular Mop 300gms (Loop End)

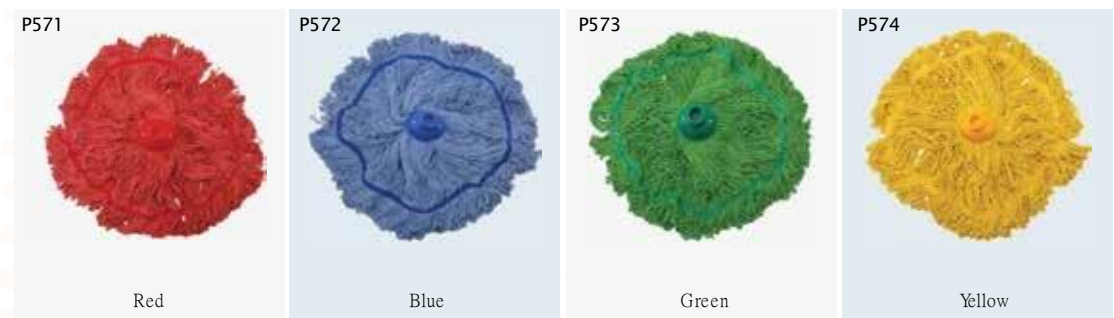

Microfibre Circular Mop 300gms (Loop End)

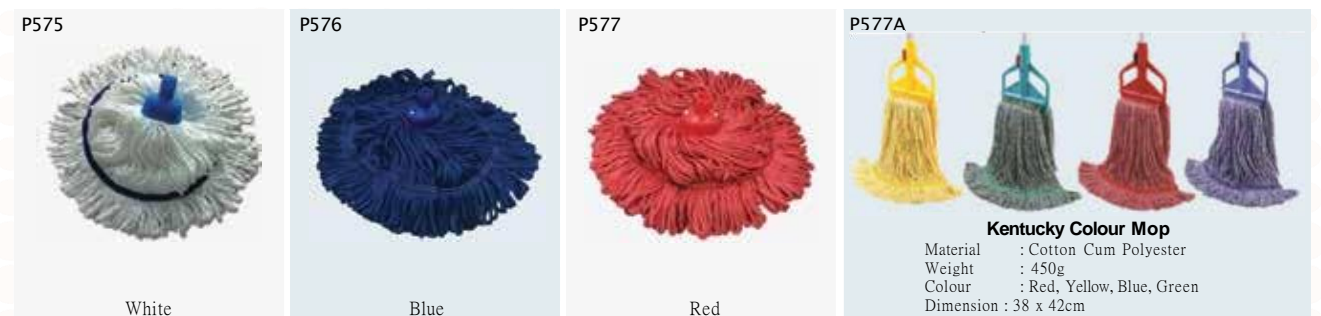









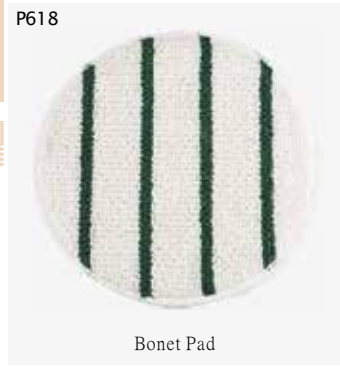







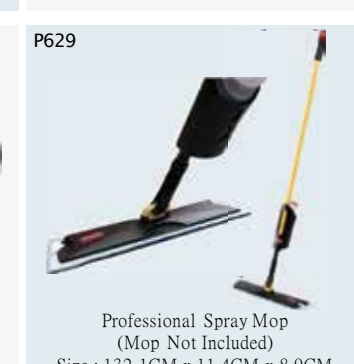

Mop Bucket Cleaning Equipment















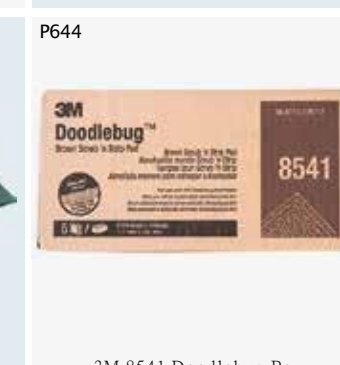
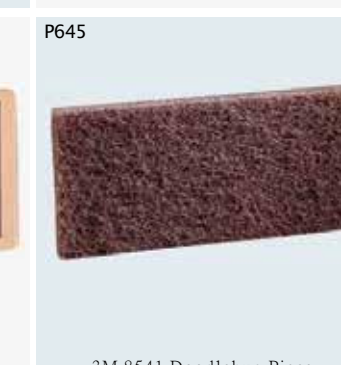

<p>P578</p> <p>Window Bucket 24 Liter 560 x 290 x 340 Ht mm</p>	<p>P579</p> <p>Plastic Pail 1 Gallon / 2 Gallon / 3 Gallon</p>	<p>P580</p> <p>Plastic Pail with Mop Press Cover 4 Gallon / 5 Gallon</p>	<p>P581</p> <p>2 compartment Bucket Capacity : 18 Liters Size : 460 x 370 x 280 Ht mm</p>
<p>P582</p> <p>Oval Mop Bucket with Wheel Capacity : 14 Liters Size : 400 x 290 x 310 Ht mm</p>	<p>P583</p>	<p>P584</p> <p>Canvas Bag (yellow) CB 90 (For Janitor Cart) CB 120 (For Maid Trolley)</p>	<p>P585</p> <p>Microfiber Flat Mop Pad Refill FMR 40 Size : 40cm L x 13 cm W FMR 60 Size : 60cm L x 13 cm W</p>
<p>P586</p> <p>Heavy Duty Chemical Spray Bottle Capacity : 500 ML</p>	<p>P587</p> <p>Aluminium Flat Mop Frame FMF 40 Size : 40cm L x 11 cm W FMF 60 Size : 60cm L x 11 cm W</p>	<p>P588</p> <p>Fiber Wick Air Freshener (40gm) Size : 65mm Dia x 65mm Ht Strong impact fragrance Fragrance : Aqua , Vanilla Bouquet, Fresh Lemon , TropicaMango. (Suitable For Most Fan Type Dispenser)</p>	<p>P589</p> <p>Chemical Spray Bottle (Flat) Capacity : 500 ML</p>
<p>P590</p> <p>FMC40 - 40cm Flat Mop complete Set FMC60 - 60cm Flat Mop complete Set Microfiber Flat Mop Complete Set come with 5 feet Aluminium Handle</p>	<p>P591</p> <p>Toilet Blue Clean, Sanitise & deodorizes the toilet bowl with each flush. Size : 65mm Dia x 73mm Ht 100 gm / pc</p>	<p>P592</p> <p>Urinal Bio Tab (Round Shape) (Enzyme Base) 50 gm/pc Urinals Odour Control</p>	<p>P59</p> <p>Urinal Bio Tab (Star Shape) (Enzyme Base) 50 gm/pc Urinals Odour Control</p>
<p>P594</p> <p>Urinal Screen (Anti-splash) 50 gm /pc Urinals Odour Control Diameter : 165mm</p>	<p>P595</p> <p>Urinal Screen (Anti-splash) 50 gm/pc Urinals Odour Control Diameter : 150mm</p>	<p>P596</p> <p>Urinal Triangle Block (Economic) (Para Base) 90 gm /pc Urinals Odour Control Diameter : 150mm</p>	<p>P597</p> <p>EMMA 820 Deo Block (Para Base) 3 / 5kg per Pail Deodorizes & Eliminate unpleasant odours</p>

<p>P598</p> <p>Cotton Dust Mop Size : 40cm, 60cm, 80cm, 100cm</p>	<p>P599</p> <p>Synthetic Dust Mop Size : 40cm, 60cm, 80cm, 100cm</p>	<p>P600</p> <p>3M Floor Pad Size : 16" ,18" ,20" Colour : White, Blue, Red, Black, Blue</p>	<p>P601</p> <p>Kentucky Mop</p>
<p>P602</p> <p>1) 3M Heavy Duty Thick Scrub Pad 9650 Size : 76W x 115D (mm) 2) 3M Light Duty Thick Scrub Pad 9030 Size : 89W x 127D (mm)</p>	<p>P603</p> <p>Floor Squeegee Size : 30" ,22" ,22"</p>	<p>P604</p> <p>Floor Squeegee Size : 35 cm</p>	<p>P605</p> <p>Size : 35 cm</p>
<p>P606</p> <p>Urinal Deodorizer Packing : 200PCS / CTN</p>	<p>P607</p> <p>Self Closing Lobby Dustpan Size : 315W x 290D x 950H (mm)</p>	<p>P608</p> <p>Disposable Plastic Bag</p>	<p>P609</p> <p>Crystal Set Window Cleaning Kit</p>
<p>P610</p> <p>Tableware Collection Tray Top Size : 535D x 380W (mm) Bottom Size : 450D x 315W (mm) Height : 150mm</p>	<p>P611</p> <p>Window Squeegee Rubber (D.L.Y) Cut It Yourself 100cm/ piece</p>	<p>P612</p> <p>Telescopic Aluminium Pole Size A : 1.5 Meter x 1 B : 1.5 Meter x 2 C : 2 Meter x 2 D : 3 Meter x 3</p>	<p>P613</p> <p>Ceiling & Wall Mop</p>
<p>P614</p> <p>Dust Mop Complete Set 40cm, 60cm, 80cm, 100cm C/W 5ft Aluminium Handle</p>	<p>P615</p> <p>Dust Mop Frame 40cm, 60cm, 80cm, 100cm</p>	<p>P616</p> <p>Stainless Steel Window Scraper</p>	<p>P617</p> <p>Flexi Clamp</p>

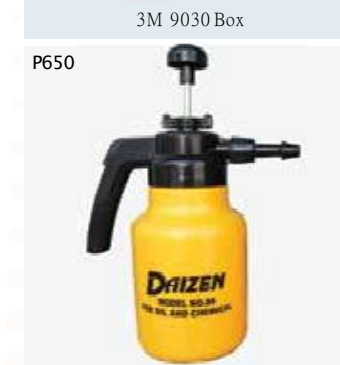
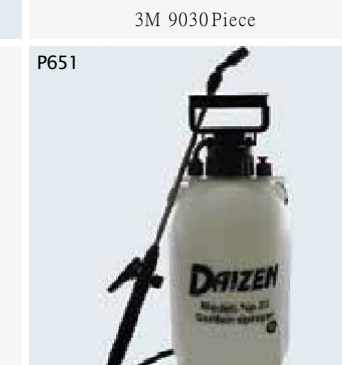
Cleaning Equipment

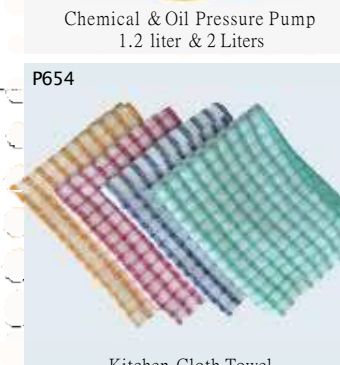
<p>P618</p>  <p>Bonet Pad</p>	<p>P619</p>  <p>Rubbermaid Mechanical Sweeper 4213</p>	<p>P620</p>  <p>Baby Changing Station Size : 58.4CM x 86.6CM x 10.2CM</p>	<p>P621</p> 
<p>P622</p>  <p>Baby Changing Station Vertical Size : 58.4CM x 86.6CM x 10.2CM</p>	<p>P623</p>  <p>Ironing Organizer Size : 13.3CM x 39.4CM</p>	<p>P624</p>  <p>Bath Mat, Medium Size : 57.2CM x 35.6CM</p>	<p>P625</p> 
<p>P626</p>  <p>Baby Chair - Wall Mounted</p>	<p>P627</p> 	<p>P628</p>  <p>Quite Dolly FOR 20-, 32-, 44-, AND 55-GALLON Size : 46.4CM DIA x 16.8CM</p>	<p>P629</p>  <p>Professional Spray Mop (Mop Not Included) Size : 132.1CM x 11.4CM x 8.9CM</p>
<p>P630</p>  <p>Cambro Ice Caddy</p>	<p>P631</p>  <p>Cambro Camtainers</p>	<p>P632</p>  <p>Cambro Camdollies</p>	<p>P633</p>  <p>Cambro Camrack</p>
<p>P634</p>  <p>Cambro Adjustable Dish Caddy</p>	<p>P635</p>  <p>Cambro Beverage Service Cart</p>	<p>P636</p>  <p>Cambro Portable Cambars</p>	<p>P637</p>  <p>Cambro Camshelving</p>

Cleaning Equipment

<p>P638</p>  <p>Doodlebug Frame</p>	<p>P639</p>  <p>Doodlebug Refill</p>	<p>P640</p> 	<p>P641</p> 
<p>P642</p> 	<p>P643</p>  <p>3M 96N (6" x 9")</p>	<p>P644</p>  <p>3M 8541 Doodlebug Box</p>	<p>P645</p>  <p>3M 8541 Doodlebug Piece</p>
<p>P646</p>  <p>3M 9030 Box</p>	<p>P647</p>  <p>3M 9030 Piece</p>	<p>P648</p>  <p>3M 9650 Box</p>	<p>P649</p>  <p>3M 9650 Piece</p>
<p>P650</p>  <p>Chemical & Oil Pressure Pump 1.2 liter & 2 Liters</p>	<p>P651</p>  <p>Garden Sprayer 5 Liter</p>	<p>P652</p>  <p>Microfiber Terry Cloth 40cm x 40cm</p>	<p>P653</p>  <p>Microfiber Glass 40cm x 40cm</p>
<p>P654</p>  <p>Kitchen Cloth Towel 28cm x 36cm</p>	<p>P655</p>  <p>Colour Towel 28cm x 36cm</p>	<p>P656</p>  <p>3M Microfiber Cloth 40cm x 40cm</p>	<p>P657</p>  <p>Good Morning Towel</p>

Your Clean Home Is Our Business



Household Detergent & Freshener

<p>P658</p>  <p>Telephone Spray 250ml</p>	<p>P659</p>  <p>3M Trouble Shooter</p>	<p>P660</p>  <p>Natural Ant Repellent Concentrate Spray 500ml</p>	<p>P661</p>  <p>Natural Mosquito Repellent Spray 500ml</p>	<p>P662</p>  <p>FiberWick Air Freshener</p>
<p>P663</p>  <p>Air Freshner Spray 300ml</p>	<p>P664</p>  <p>3M Stainless Steel Polish 600g</p>	<p>P665</p>  <p>Airnergy Charcoal Deodorizer Gel 60gm</p>	<p>P666</p>  <p>Netcare 9 In 1 Floor Cleaning</p>	<p>P667</p>  <p>Autozone Protectant Spray 300ml (Premium)</p>
<p>P668</p>  <p>Air Fresh Para Block Heart 90gm</p>	<p>P669</p>  <p>AWA Eco Wick Non Alcohol Air Freshener Compatible for most Fan Type Dispenser or Stand-alone, long lasting fragrance, last up to 60 days</p>	<p>P670</p>  <p>Air Freshener Gel-Type 80g 3-in-1-Lavender</p>	<p>P671</p>  <p>AWA Metered Air Freshener Refill Compatible for most Aerosol Dispenser Last up to 3000 Spray Non CFC, Ozone Friendly</p>	<p>P672</p>  <p>Automatic Air Freshener Dispenser Starter Pack</p>

Household Detergent & Freshener

10 

You Are The Key To Your Safety



Brand:



Safety Products



P688
WORKER Safety Helmet
 Outer Layer is Made of Virgin Polyethylene (PE) Which is highly protected against high impact. Manufactured In Malaysia with latest specifications and up to date design model.
 Colour : White, Yellow, Orange, Blue & red. 50 set /Carton



F 689
WORKER Safety Helmet
 Art number :800
 Outer Layer - Made of Virgin ABS Material
 Inner Shell - Made of durable Polypropylene Material.
 Helmet bands- Made of finely knitted cotton
 Made In Malaysia
 Colour : Yellow , White , 40 sets / Carton



P690
WORKER Safety Helmet
 Art Number : 900
 colour : White, Yellow.
 Ratcheted Function Solid Wheel
 (Easy to tighten & loosen the helmet cap)
 Foam Knitted Head Cap
 (Comfortable to wear & High Quality Helmet cap ensure the users are well protected with WORKER helmet.)
 Made In Thailand



P691
WORKER Safety Helmet
 Art number : SC900
 colour : White, Yellow, Orange, Blue & red.
 Material: ABS
 Ratcheted Function Solid Wheel
 (Easy to tighten & loosen the helmet cap)
 Foam Knitted Head Cap
 (Comfortable to wear & High Quality Helmet cap ensure the users are well protected with WORKER helmet.)
 Made In Thailand



P692
 3M Securefit Eyewear 3410
 (In & Outdoor)



P693
 Safety Eyewear Tinted



P694
 Visitor Safety Eyewear



P695
 Anti Fog Google



P696
 Ear Plug



P697
 3M 8246R95
 Acid Gases Particulate respirator
 20 pcs / box



P698
 3M 8246



P699
 Earmuff



P700
 Earmuff Supersonic



P701
 3 Ply Surgical Mask



P702
 3M 6200 Half Mask



P703
 3M Mask Cartridge Gas & Vapor



P704
 Emergency Fire Escape Mask EN 403



P705
 3M-6800 Full Face Respirator



P706
 Fireman Suit - Nomex



P707
 Fire Retardant Coverall



P708
Chemical Boiler Suit
 Application : Suitable for all types of chemicals ,cover with hook .
 Size : M / L/ XL



P709
 Cotton Cover All With 6 Reflective



P710
 Cotton Cover All



P711
 Non Woven Coverall



P712
 Kleenguard Cover All



P713
 Cold Room Jacket



P714
Marine Life Jacket
 - Ligh weight & easy to wear
 - Comes with 2 pcs x 40 mm waist strap & 1 pcs crotch strap & whistle to attract attention during emergency
 - Micro-prismatic material on collar.
 - SIRIM test report : No 2005MA0686
 - Size: S, M, L, XL



P715
 Life Jacket Economic
 Comes with 2 Channel whistle to 4 Reflector
 Size : Free size



P716
 Heavy Duty Rain Suit With Reflective



P717
 Heavy Duty Rainsuit



P718
 Heavy Duty Raincoat



P719
 Chemical Protective Apron



Safety Products

Safety Products



P720



M 8000
 Height: 350mm, Weight: 1.8kgs
 Packing: 1 Pair / Box, Size Range: 39 to 44
 Gross Weight: 2.1kgs, Lining: Polyester
 Material: Polyvinyl Chloride, Colour : Yellow
 Top Cap Material: Carbon Steel C50 EN12568
 1.7mm Thickness
 Midsole Material: Stainless Steel EN12568

P721



M /000
 Height: 350mm, Weight: 1.8kgs
 Packing: 12 Pair/ carton, Size: 37-44
 Lining: Polyester, Material: Polyvinyl Chloride
 Colour: White / Yellow
 Chemical & Oil Resistant Sole.
 Soft Urethane PVC Sole
 For Strength & Comfort

P722



M 6000
 Height: 320mm, Weight: 1.5kgs
 Packing: 50 Pairs / Bag,
 Size Range: 37 to 44
 Gross Weight: 75.3kgs,
 Material: Polyvinyl Chloride
 Colour: Yellow / Black
 Chemical & Oil Resistant Sole.
 Soft Urethane PVC Sole
 For Strength & Comfort

P723



808A
 Midsole And Steel Toe Cap
 Colour: Black with beige shoe base
 Yellow with black shoe base
 Height: 400mm, Weight: 1.95kgs
 Packing: 1 Pair / Box, Size Range: 37-44
 Lining: Polyester, Insole: EVA (G-1)
 Upper Sole Material: Polyvinyl Chloride
 Sole Material: PVC Nitrile
 Toe Cap Material: Carbon Steel C50
 EN12568 1.7mm (Thickness)
 Midsole Material: Stainless Steel EN12568

P724



664-68 (Cripier)
 Size : 5- 10 (UK)
 - Nail Proof EN:12568
 - Genuine Leather Upper
 - Shock Absorption
 - Normal Industrial Oil,
 Acid & Alkaline Resistance
 - Nitrile Rubber Sole
 - Steel Toe Cap to withstand 200
 Joules EN:12568

P725



NITTI
21281 - Lace
21381 - Velcro & Ventilated
 Type: Low Cut
 Size: 2-14 (UK) / 35-48 (EU)
 Colour: Black
 Upper: Genuine Leather
 Lining: Genuine CambrelleÆ
 Outsole: Direct Injection Polyurethane
 Rating: CE EN 20345-1 S1PSRC
 Provides great comfort while exceeding the
 basic safety requirements.

P726



NITTI
22281 - Lace
22681 - Zipper
 Type: Mid Cut 7
 Size: 2-14 (UK) / 35-48 (EU)
 Colour: Black
 Upper: Genuine Leather
 Lining: Genuine CambrelleÆ
 Outsole: Direct Injection Polyurethane
 Rating: CE EN 20345-1 S1PSRC
 Premium quality finishing including the
 anti-rust brass eyelets and tough-wearing
 shoelaces provide the ruggedness and
 durability.

P727



NITTI
23281 - Pull-on,
23381 - Zipper
 Type: High Cut 10'
 Size: 2-14 (UK) / 35-48 (EU)
 Colour: Brown / Black
 Upper: Full Grain Water Resistant Leather
 Lining: Genuine CambrelleÆ
 Outsole: Direct Injection Polyurethane
 Rating: CE EN 20345-1 S3SRC
 Delivers superior comfort in harsh industrial
 environments.
 Ideal for the marine and oil & gas industries.

P728



Work positioning seat Harness
 Abrasion Proof & Wide back comfort pad.
 2 pcs lateral positioning D- rings with 1pc front
 waist work positioning D-ring curved D-rings tofacilitate
 connection to hooks.
 Come with PGO190 MPB multi Purpose bag.
 Conform to BS EN358, EN813 & SIRIM
 certification No :PP071006
 - Sizes: Universal

P729



Safety Harness PG-141060-CBU
 - 1-pcs dorsal attachment D-ring
 - Metal buckle type chest strap
 - Adjustable thigh strap
 - Available in Red/ Yellow Orange/Black colour
 - Ideally positioned sit strap for extended comfort
 - Comes with PG 0190 MPB Multi Purpose Bag
 - Conform to BS EN 361 & SIRIM certification no:
 PPO71003
 - Sizes: Universal

P730



Construction Safety Netting

P73



Green Safety Netting
 Made of high density polyethylene or polyethylene
 is widely used in the construction sites, which helps
 prevent the workers and building materials from falling
 down and avoid possible harms to the passing
 pedestrians caused by the falling materials.
 Size :1.8 meter x 5.1 meter
 Weight : 1kg +/-0.5kg
 Packing : 20pcs/pack

P732



1A9-DF (Aluminium Stretcher)
 Double Fold Stretcher
 With sewn-on 2 strap in Carrying Bag
 It made of high-strength aluminum alloy
 with Durable Waterproof PVC Coated Nylon Canvas
 1000D Orange color.
 Unfolded Size : L221 x W 53 x H 15cm
 Folded Size Self : L 110 x W 18 x H 11cm
 Weight : 5kg , Load Bearing : 159kg

P733



WCH/5260-SD (Wheel Chair)
 Features:
 -Foldable 3 layers chromed steel frame
 -Fixed armrest & footrest
 -Solid front castors:20cm
 -Solid rear tyres:58cm
 -PVC seat width:50cm
 -Weight:17kg
 -Max load:100kg

P734



Fire Blanket
 Use to quench and resist fire spreading.
 Ideal to standby in office, warehouse, ship, car,
 house, kitchen, restaurant, amusement building,
 gas station etc. Can also be used to wrap around your
 body and act as a heat shield.
 Isolates high temperatures up to 900° or 580°.
 Material: Fiberglass cloth
 Specifications of Fire Blanket - 1.2m x 1.8m & 1.2m
 x1.8M

P735



EC-1 (Fire Extinguisher)
 SIRIM Certified
 Gross Weight 1.8kg, Content Weight 1.0kg
 ABC Dry Powder, for almost all types of fire
 Non Toxic, Steel Casing with Powder Coating
 Durable & Serviceable, Indicator Gauge
 Mounting Bracket, Quick Release
 Highly Recommended for modified cars

P736



Safety Vest N Series

P737



Safety Cotton Vest

P738



Safety Vest 3M

P739



Safety Vest Economy Series

P740



Safety Vest F Series

P741



Safety Vest LED

P742



T-Shirt With Reflector

P743



Safety Vest V Series

P744



Spill Kit (Large) 240 Lit Wheel Poly Bin

P745



Spill Kit (Medium) Economic Poly Wheel Bin 120 Liters

P746



Spill Kit Portable Drum

P747



Chemical Sorbent Pillow

P748



3M Sorbent Folded Pad

P749



Chemical, Oil, Universal Absorbent Boom

P750

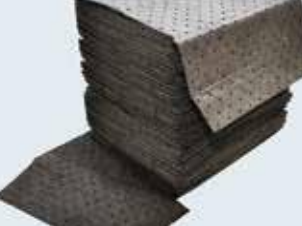

Chemical Sorbent Pad

P751



Fire Extinguisher Stand

Personal Safety Equipment ■ Safety Products



 P752 Nylon Glove Without Finger	 P753 PE Glove	 P754 Pokka Dots Glove	 P755 Eurica PU Grip Winter Glove
 P756 Red PVC Glove	 P757 Ansell 09-430 Shoulder Length	 P758 Ansell 09-924 Chemical Resistant	 P759 Ansell 19-026 Heat & Chemical Resistant
 P760 Ansell 198FL 100 Chemical Resistant	 P761 Ansell Alphatec	 P762 Ansell Aluminised Heat Resistant	 P763 Ansell Barrier2-100 Chemical Resistant
 P764 Ansell Chemi-Pro Chemical Resistant	 P765 Ansell Chemtec	 P766 Ansell Cool Resistant Polar Grip	 P767 Ansell Crusader Heat Resistant

 P768 Ansell Cut Resistant	 P769 Ansell Heat Resistant Thermal Liner	 P770 Ansell Hycron (Extra Duty General Purpose)	 P771 Ansell Hynit
 P772 Ansell Neoprene 29-865 Chemical Resistant	 P773 Ansell NitraSafe Cut Resistant	 P774 Ansell Nitrile Coated Glove	 P775 Ansell PETROFLEX 12-214 Chemical Resistant
 P776 Ansell Powerflex	 P777 Ansell ProFood	 P778 Rubber Household Glove	 P779 Ansell PVA 15-554 Chemical Resistant
 P780 Ansell Scorprio 08-354	 P781 Ansell Scorprio 09-928 Chemical Resistant	 P782 Ansell Scorprio Neoprene	 P783 Ansell Solvex 37-85, 18 Chemical Resistant



Safety Products

 P74 Ansell Solvex 37-676 Chemical Resistant	 P785 Cold Resistant 495PVC Glove	 P786 Cold Resistant Glove	 P787 Cold Resistant Showa Thermo Glove
 P788 Cut Resistant 316 Stainless Steel	 P789 Cut Resistant Dydeema Glove	 P790 Electric Insulation Glove (Yellow)	 P791 Electric Insulation Glove
 P792 ESD Anti Static	 P793 ESD Palm Fit	 P794 ESD Top Fit Glove	 P795 ESD with PVC Dotted Gloves
 P796 Fire Fighter Glove	 P797 Fireman Glove	 P798 Full Aluminised Heat Resistant Glove	 P799 Full Aluminized Heat Resistant Glove

Safety Products

 P800 Full Leather Gray Glove	 P801 Furniture Semi Leather Glove	 P802 Kelvar Cut Resistant Glove	 P803 Kelvar Cut Resistant With Dots Glove
 P804 Kelvar Cut resistant with Nitrile Coated Glove	 P805 KleenGuard Nitrile Coated Glove	 P806 Powder Free Latex Glove	 P807 Powder Free Nitrile Glove
 P808 Powder Free Vinyl Glove	 P809 PU Coated Glove	 P810 PU Coated TopFit	 P811 PVC Coated Glove
 P812 PVC Dotted Cotton Glove	 P813 PVC Dotted Gloves	 P814 Showa 600 PVC Coated Glove	 P815 Showa 660 PVC Coated Glove





Personal Safety Equipment

11

Our Aim, No Accidents

<p>P816</p>  <p>Showa 720 Nitrile Coated Glove</p>	<p>P817</p>  <p>Showa Green Grip (Nitrile Grip)</p>	<p>P818</p>  <p>White Button Glove</p>	<p>P819</p>  <p>Zetex Plus Heat Resistant Glove</p>
<p>P820</p>  <p>White Nylon Glove</p>	<p>P821</p>  <p>Argon Leather Glove</p>	<p>P822</p>  <p>Black PU Coated</p>	<p>P823</p>  <p>Blue Jean Semi Leather Glove</p>
<p>P824</p>  <p>Green Full Leather Glove</p>	<p>P825</p>  <p>Heat Resistant Red Leather Glove</p>	<p>P826</p>  <p>Impact Glove (Oil & Gas, Mining)</p>	<p>P827</p>  <p>Knitted Cotton Glove</p>
<p>P828</p>  <p>Long Nitrile Chemical Glove</p>	<p>P829</p>  <p>Long PE Glove</p>	<p>P830</p>  <p>Neoprene Chemical Glove</p>	<p>P831</p>  <p>Nitrile Chemical Glove</p>

Road & Traffic Safety

We are successfully engaged in trading and supplying a commendable range of Traffic Safety Equipment. Besides being manufactured at our vendors' end using quality assured raw material, provided products are tested on various parameters of quality.

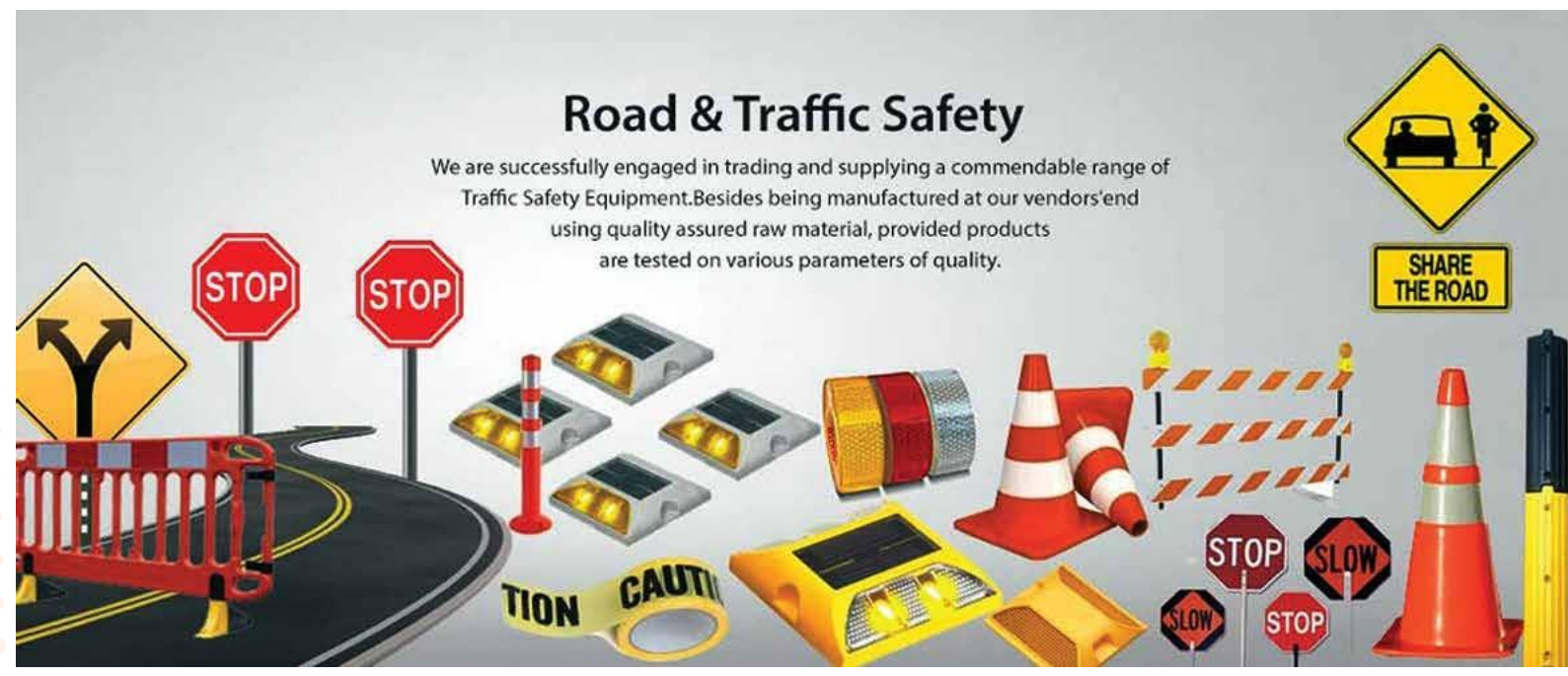

The advertisement features a collection of traffic safety equipment including: a yellow diamond-shaped sign with a car and pedestrian icon, a red octagonal 'STOP' sign, a yellow 'SHARE THE ROAD' sign, a yellow 'Y' junction sign, a red and white striped traffic cone, a yellow 'CAUTION' sign, a red and white striped traffic barrier, a yellow traffic light, and a red and white striped traffic sign.



Road & Traffic Safety

P832



A-Standing Caution Sign
 Wording : Cleaning In Progress, Caution Wet Floor, Work In Progress
 Open : 26" LX 11" W X 25" H
 Closed : 26" LX 11" W

P833



Caution Sign (Large)
 Size : 320W x 320D X 1170H (mm)
Caution Sign (Small)
 Size : 280W X 280D X 930H (mm)

P834



Heavy Duty Plastic Mobile Barrier
 Height: 1000mm , Base Width: 300mm
 Max Length: 3900mm , Weight: 15.0kg

P835



Mobile Barrier
 Size : 2000W x 620D x 1030H (mm)

P836



PU Elastic Pole - Heavy Duty
 Dimensions: 80mm, 75mm, 1000mm, 390mm, 200mm, 750mm, 270mm, 450mm, 180mm, 200mm

P837



Metal Bollard (Large)
 Size : 170(Dia) x 830H (mm)
 Base Size : 300mm x 300mm
 Option : With Or Without Hook
Metal Bollard (Small)
 Size : 100mm (Dia) X 820mm (H)
 Base Size : 150mm X 150mm
 Option : With Or Without Hook

P838



Fiber Reinforce Bollard
 912mm (H) x 195mm diameter (top)
 186mm Diameter (round base)

P839



Adjustable Parking Pole
 63mm x 63mm x 820mm (Ht) Base
 190mm x 200mm (L)
 With Locking Bracket

P840



Collapsible Parking Pole
 Pole : 75mm (Dia)
 Bottom Plate : 150W x 150D (mm)
 Total Height : 800mm
 Features : With Locking Bracket

P841



HIP Reflective Sticker
 Sheets roll size 1.24 m x 45.7m ,
 printable Reflective sheeting roll
 for Traffic Signs

P842



EG Grade Reflective Sticker
 1.22 Meter x 45.7 Meter
 Colour : Red, White, Yellow,
 Orange, Blue & Green
 Packing : 1 roll

P843



Wheel Lock (Large)
 Colour : Yellow
 Features : 17" And Above Wheel Base
Wheel Lock (Small)
 Colour : Yellow
 Features : Up To 16" Wheel Base

P844



No Parking Stand
 Size : 230 x 460 x 1200 (Ht)
 P Signage Diameter : 460mm

P845



Reserved Parking Stand
 Size : 490W x 310D x 1135H (mm)
 Board size : 490W X 320W (mm)

P846



Clamping Signage
 305 x 457 mm (27 x 18")

Road & Traffic Safety

P847



Aluminum Road Stud
 Size : 100mm x 100mm x 70mm
 Nail Length : 50mm

P848



2-Way Aluminium Road Stud
 Brand : 3M
 Size : 100mm x 100mm x 95mm
 Impact and abrasion resistance

P849



K-lite Aluminium Road Stud
 Size: 102 x 102 x 22 mm
 Material : Shell-Aluminium
 Filling : Epoxy glue and quartz sand
 Spike : 50 mm
 Colour : Amber / Red & White

P850



AWAS Tape /CAUTION Tape
 Colour : (Red & White), (Black & Yellow)
 Non-Adhesive
 Size : 3" x 50M

P851



PVC Floor Marking Tape
 Size : 3" x 30 yard
 Resistant to oil, moisture, solvents and scuffing, Highly durable and has strong holding strength, can even withstand forklift traffic, Ability to stick to virtually any dry surface when applied, Long-lasting adhesiveness and tape quality.

P852



Anti-Slip Tape 1/3 Photo luminescent & Black
 Size : 50mm (W) x 18 meter (L)
 Colour: Black with Green Stripe (Glow in the dark)
 Application: Loading docks, kitchen/ food service Floor, Cinema floor, etc

P853



Reflective Delineator String (Delineator Rope)
 Material : PVC reflective
 Size : 50 Meter / Roll

P854



Barrier Delineator
 Size: 112(L) x 92mm(H)
 Colour: Grey, Yellow
 Material: LDPE Plastic
 Reflector: 3M High Intensity Prismatic (can be customized upon request)

P855



Barrier Netting
 Size : 1 x 50 meter
 Weight : 6 kg
 Made from durable PE

P856



Blinker
 Weatherproof against rain, sun, snow and heat.
 Universal mounting brackets for barricades and pipes
 Viewing Distance achievable of over 1000 meters
 Power : 1pc / 2pc x 6V Battery
 Service Time: Up to 2200 Hour

P857



Emergency Triangle Reflective Stand

P858



Extensible Barrier
 Powder Coated Mild Steel
 Size : 1 Meter x 3 Meter (Ht)

P859



Safty Baton
 Revolving Light
 Size : 530 mm (L) x 40mm (Dia)
 2 pcs D Size Battery

P860



Retractable Warning Belt For traffic Cone
 Height : 230mm
 Weight : Approx 0.3KG
 Belt size : 50mm (W) x 3 meter (L)
 Belt Colour : Red/White , Yellow/Black
 Material : UV stabilized plastic body & fabric belt

P861



Robotic Traffic Flagman
 Operated By Battery /Solar

P862



T-Top Bollard
 Material : PE pole and Rubber Base
 Size : Post 1150 mm Ht
 Base 420 x 420 mm
 Weight : Post 1KG
 Base 6 kg



Road & Traffic Safety

P863

Full Dome convex Mirror
360 view full Dome (ceiling type), Material: Acrylic
Size: 600, 800mm Diameter

Acrylic Convex Mirror
Indoor - 600mm, 800mm

Acrylic Convex Mirror
Outdoor - 600mm, 800mm

P864

Stainless Steel Convex Mirror
600mm

Stainless Steel Convex Mirror
800mm

Stainless Steel Convex Mirror
1000mm

P865

REFLECTIVE TAPE - Sparkling HIP
Self Adhesive
2' x 150 feet (50mm x 46 meter)+-
Colour : Red , Yellow, white

P866

ARROW REFLECTIVE TAPE
Adhesive Sparkling HIP
Size : 50mm x 46 meter
Colour : Red & Yellow

P867

Honeycomb Reflective Sticker Adhesive
Size : 2' x 50 Meter
Colour : Red & White

P868

Anti-Slip Floor Tape (ASFT 218)
2' x 60 feet (50mm x 18 meter)+-
Colour : Black / Yellow / Black & Yellow
Self Adhesive Rough Surface

P869

Fabric Polyester Reflective Tape
Size:1 inch, 2 inch
Size/roll :200 Meter

P870

PVC Reflective Tape
Size : 1' / 2' / 4' Colour
: White / Orange / Lime
Green / Yellow
Size/roll : 50 Meter

P871

Plastic Chain
Size : 6mm x 25 Meter
Colour : Yellow , Red , White

P872

Wall Mouted Retractable Belt Barrier
Belt size:
50mm width and 3 meter long.
Belt Colour:
Red/White , Yellow/Black
Material:
UV stabilized plastic body & fabric belt

Road & Traffic Safety

P873

Arrow Corner Guard
210mm (W) x 800MM (L)
x 35mm Thickness

P874

Corner Guard
Material : Nitrile Rubber (Heavy Impact)
with yellow reflective tape
Size : 100mm x 100mm x 800 mm (Ht)
Thickness : 10 mm

P875

Heavy Duty Wheel Chock
Material: Synthetic Rubber
Grip Handle for easy Handling
270mm(L) x 120mm(W) x 180mm(Ht)
3.3kg / Wheel Chock

P876

Rubber Speed Hump
Size : 500mm(L) x 350mm(W) x 50mm(Ht)
End Piece Size : 175mm(L) x 350mm(W) x 50mm(Ht)
Material : Synthetic Rubber
Pressure Resistance : 20 ton
Net Weight : 5.8kg/pc (Middle)
Characteristics:
-Available in black and yellow colour for greater
visibility with cats-eye reflectors
- UV,moisture and temperature resistant

P877

Portable TPU Speed Hump
Size :3000mm (L)x 250mm (W) x 25mm (Ht)
Weight - 12kg
Bearing Weight - About 20 tonnes
Material : Durable Polyurethane

P878

Portable Rubber Speed Hump
Size :3000mm (L) x 230mm (W) x 45mm (Ht)
Weight - 13kg
Roll Up Size - 540mm Diameter
Bearing Weight - About 13 tonnes
Material : Polyurethane Top & Rubber Base

P879

Natural Rubber Speed Hump
Size : 250mm(L) x 350mm(W) x 50mm(Ht)
End Cap Size : 175mm(L) x 350mm(W) x 50mm(Ht)
Material: NATURAL RUBBER
(Made In Malaysia)

P880

Rubber Wall Guard
160mm (W) x 1000MM(L)
x 50mm Thickness

P881

Rubber Kerb Ramp
Size : 480mm(L) x 420(W) x 110(H)mm
Weight : 13 Kg/Pc
Material : Synthetic Rubber

P882

Dock Bumper
DB 33 (Square)
330 (L) x 250 (W) x 102mm (H)
DB 45 (Rectangular)
450 (L) x 250 (W) x 102mm (H)

P883

2 Channel Cable Ramp
Outside Size: 1000x250x50mm
Channel Size: 30mmx25mm

3 Channel Cable Ramp
Outside Size: 1000x310x50mm
Channel Size: 35x35mm

5 Channel Cable Ramp
Outside Size: 770x485x50mm
Channel Size: 42x40mm

Cable Hump

P884

Traffic Lane Block flexible Post
Base Weight : 12kg
Base Material : Recycle Rubber
Post Height : 815 mm
Post Weight : 1kg
Base size : 800L x 200W x 130H mm
Post reflective material:
USA import "Relexite" mark
(Diamond grade reflective sticker)
Base Reflective Material:
Yellow glassbeads reflective pastar
Sunshine resistant Material grade : > 7
Post Material : TPU
Base Maximun loading capacity : 5 tons

P885

Wheel Stopper (WSR 500)
Material : Synthetic Rubber
550mm x 150mm x 100mm(Ht)
Weight : 4.5kg

P886

DF 10 D-Fender
D Shape Dock Bumper
900 (L) x 100 (W) x 100mm (H)
DF 20 D-Fender
D Shape Dock Bumpers
900 (L) x 200 (W) x 200mm (H)

P887

Truck Hump
Heavy Duty Rubber Speed Hump
with arrow reflectors
400 (W) x 75 (H) x 500 (L)mm
End Piece 400 (W) x 75 (H) x 250
(L) mm
Load capacity up to 25 tons



Share Your Information On Me



P888
Traffic Cone Topper With Retractable Safety Belt
 Body material : PE
 Total height : 230mm
 Total height : 300mm
 Topper colour : Red or Yellow
 Belt Expand length : 3 meters
 Belt width : 50mm
 Stripes belt colour : Yellow / Black or Red / White



P889
Cone Blinking Light
 2 transparent sides with Internal Switch Ultra bright LED
 Voltage : 3V
 Battery : 2 x 1.5V AAA alkaline
 Power Consumption : 0.05W
 Visible Distance : 250m-350m
 Operating time : 200-500 hours continuous flickering
 Flashing Frequency : 65 Flashes p/min with +/-5%



P890
Collapsible Cone with LED
 Height : 550mm
 Base : 280 x 280 mm



P891
Triangle Cone
 Height : 25"
 c/w Reflective Sticker
 Dimension : 430 x 430 x 650mm Ht



P892
Quad Ring Cone
 Height : 28"
 Colour : Red, Yellow & Blue
 Weight : 5kg



P893
PVC Traffic Cone (Highway Spec)
 H : 28" (4.5kg), 36" (3.5kg), 36" (4kg)
 Material : Soft PVC Rubber Base
 Base : 360 x 360 (mm)
 Reflector : High Intensity (HIP)



P894
Adaptor Traffic Cone (PE)
 750mm (H) with 6" white collar reflector
 Adaptor Base :
 510mm (W) x 510mm (L) x 270mm (H)
 Adaptor can fill in water or sand



P895
Triangle Cone
 Height : 25"
 c/w Reflective Sticker with
 POLIS Or JPJ wording
 Dimension : 430 x 430 x 650mm Ht



P896
Sand Base PE Traffic Cone
 Height : 30" & 40"
 Colour : Orange
 Weight : 2.2kg, 5.2kgs



P897
Super Traffic Cone
 Material : PE
 1,067mm (H)
 with square base 510mm x 510mm



P898
TC 18
 Material : PE / PVC
 Reflective Sticker
 Height : 18" Base 240 x 240mm



P899
Collapsible Square Traffic Cone
 Height 670mm
 Base size 300mm x 300mm
 Weight approx 2.5kg
 Material polyethylene medium density (PE)

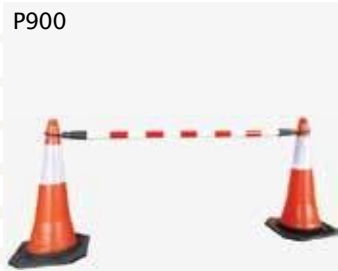

P900
Expandable Cone Bar
 Material : ABS
 Bar inner Dia 35mm Outer dia 40mm
 Ring dia 100mm
 Extends from 1.2 meter to 2 meter



P901
Chain Hook For Traffic Cone
 Material : HDPE
 Colour : Red with UV stabilized
 Size : 82 (top) x 92 (bottom) x 28H (mm)



P902
BP 30
 Height : 750mm
 Base Size : 380mm x 380mm
 Reflective Sticker
 Option : Chain Holder







P903
Road Barrier
 Dimension : 100mm (Top), 500MM (Base)
 x 800mm Ht x 1000mm (L)
 Colour : Red or white
 Weight : 8 to 10kgs



Display & Notice Board

13 

Keep Insect A Bay & Germs Away

<p>P904</p>  <p>Poster Stand Height Adjustable, Powder Coated Steel Tube & Aluminium Frame Frame Size: A4 x (80- 120 cm)Ht Frame Size: A3 x (89- 124 cm)Ht Frame Size: A2 x (95- 128 cm)Ht</p>	<p>P905</p>  <p>3 Tier Display Poster Frame Powder Coated Steel Tube & Aluminium Frame Frame: A4 x (Base 34 cm Dia x 155 cm Ht) Frame: A3 x (Base 34 cm Dia x 170 cm Ht)</p>	<p>P906</p>  <p>DIDI Display Stand Height Adjustable & Tilttable Powder Coated Steel Tube & Surface Face Size : 32cm W x 45cm L Height : (82- 120 cm) x 45cm L Base 34cm Dia</p>	<p>P907</p>  <p>Manual Board Available in single or double sided Writing surface available in whiteboard or chalkboard Epoxy enamel finish for long term durability 55cm L x 50cm Depth x 137cm Height</p>	<p>P908</p>  <p>EA Poater Stand Available in single or double sided Quick Fold For Easy Storage, required no assembly. Durable Highgrade Aluminium & Powder Coted Steel tube A2 - 48mm Lx 56cm Depth x 104cm Height A1 - 65mm Lx 49cm Depth x 129cm Height</p>
<p>P909</p>  <p>Mobile Panels Full steel frame with perforated bottom panel Use multiple panels together to create a group display. Lockable castors for mobility and stability Stand frame colour: Dark Grey Fabric Colour : Purple, Red, Blue, Green , Gray & Black. A. 94cm Lx 43cm Depth x 180cm Height B. 94cm Lx 43cm Depth x 210cm Height C. 124cm Lx 43cm Depth x 180cm Height D. 124cm Lx 43cm Depth x 210cm Height</p>	<p>P910</p>  <p>Mobile Double Sided White Board Available in 3 surfaces, Melamine, Coated Steel & Enamel. Pivots 360 degrees for easy use on both sides. Spring Lock for quick secure board. Pen tray on stand for easy access to markers & erasers. Epoxy enamel finish for long term durability. Lockable nylon castors for easy mobility and stability A. 90cm Lx 60cm Ht Assembled Size: 90cm Lx 50cm Wt x 157cm Ht B. 120cm Lx 90cm Ht Assembled Size: 120cm Lx 50cm Wt x 175cm Ht C. 150cm Lx 90cm Ht Assembled Size: 150cm Lx 50cm Wt x 190cm Ht D. 180cm Lx 90cm Ht Assembled Size: 180cm Lx 50cm Wt x 190cm Ht E. 180cm Lx 120cm Ht Assembled Size: 180cm Lx 50cm Wt x 205cm Ht</p>	<p>P911</p>  <p>News Paper & Magezine Rack Includes 3 newspaper clamp 1 steel display rack Oval steel tube construction Colour combination of Dark Grey and Silver Size : 68cm Lx 44cm W x 79cm Ht</p>	<p>P912</p>  <p>Plan Hanger Stand (Front Loading) Accepts both A1 and A0 plan hangers Will accommodate up to 35 plan hangers (maximum varies on size) Hangers easily accessible Made from high quality steel and epoxy enamel finished for extra durability. Lockable nylon castors for easy mobility and stability.</p>	<p>P913</p>  <p>Roll Upright Storage 12 Slot - 50cm Lx 38cm W x 75cm Ht 18 Slot - 72cm Lx 38cm W x 75cm Ht 21 Slot - 83cm Lx 38cm W x 75cm Ht Full steel construction, Lockable castors, Colour : Dark Grey</p>
<p>P914</p>  <p>Foldable Leaflet Stand 361 Material : Aluminium 37cm Lx 50cm W x 152cm Ht</p>	<p>P915</p>  <p>Leaflet Stand 333B Powder Coated Full steel construction 4 pcs A4 Size Solid Tray 29cm Lx 35cm W x 108cm Ht Lockable castors</p>	<p>P916</p>  <p>Executive Rostrum Modern design for powerful delivery of communication. Decorative steel bars enforce stability & durability 49cm Lx 49cm W x 116cm Height</p>	<p>P917</p>  <p>Suggestion / Complaint Box Transparent Acrylic Window Aluminium Frame With lock A. 12 Length x 22 Depth x 29 Height (cm) B. 13 Length x 16 Depth x 34 Height (cm)</p>	<p>P918</p>  <p>First Aid Box Transparent Acrylic Window Aluminium Frame with lock A. 30cm Length x 11cm Depth x 27cm Height B. 34cm Length x 13cm Depth x 29cm Height</p>
<p>P919</p>  <p>Key Cabinets Solid steel construction Epoxy coated for durability (Colour : Light Grey) Good quality cam lock, inclusive of 2 keys Magnetic catch for added grip Galvanized and colour coded metal key tags for easy organisation Wall mounted or stand alone (wall fixing plugs & screw included) 32 Keys - 26.2cm Lx 5.2cm W x 38.5cm Ht 48 Keys - 26.2cm Lx 5.2cm W x 48 cm Ht 72 Keys - 37.5cm Lx 5.2cm W x 45cm Ht 96 Keys - 37.5cm Lx 5.2cm W x 59cm Ht 120 Keys - 37.5cm Lx 5.2cm W x 73.8cm Ht 150 Keys - 41.5cm Lx 7cm W x 73.8cm Ht</p>	<p>P920</p>  <p>Display Case Notice Board Aluminium window display case with acrylic hinged door. Key-Lock provided to secure information. Can be positioned with door opening on the left, right or bottom side A. 60cm Lx 45cm Ht B. 90cm Lx 60cm Ht C. 120cm Lx 90cm Ht D. 150cm Lx 90cm Ht E. 180cm Lx 180cm Ht</p>	<p>P921</p>  <p>Key Panels Store, retrieve and view available keys Key and lock to control access Rollers installed for smooth glass panel sliding Can also be used to hook and display other small sized items 96 Hooks - 90cm Lx 7.5cm W x 60cm Ht 126 Hooks - 90cm Lx 7.5cm W x 60cm Ht 220 Hooks - 120cm Lx 7.5cm W x 90cm Ht 290 Hooks - 120cm Lx 7.5cm W x 90cm Ht</p>	<p>P922</p>  <p>Wall Mounted Poster Standard Frame Aluminium clip-framesystem Suitable for both indoor and outdoor use Size : A4, A3, A2 , A1</p>	<p>P923</p>  <p>Sliding Glass Notice Board Aluminium Frame Share & protect information Easily update information with smooth sliding glass window Key-Lock provided to secure the information A. 90cm Lx 60cm Ht B. 120cm Lx 90cm Ht C. 150cm Lx 90cm Ht D. 180cm Lx 90cm Ht E. 120cm Lx 120cm Ht</p>



Insect Trapper & Fogger

Our Insect Trap uses a specific application fluorescent black light chemical lamps from Philip & NEC, Japan to attract flying insects to be trapped by the temperature optimized glue board that can easily be replaced.

This range of Sticky flies trap have innovative designs with decorative and unique covers to hide the glue board and insect catch, providing discreet and environmentally friendly fly control, is a premium choice for HACCP food management programs, restaurants, bakeries, food processing factories, canteen, cafeteria, food court.

P924



Mini Fogger KB-100

Type : Mini Mist Fog
 Dimensions : 600mm x 175mm x 420mm
 Weight : 2.5kg
 Fuel : Liquid Propane Gas
 Fuel Consumption : 1EA/30 minutes
 Starting Method : Ignition Button
 Fuel Tank Capacity : 2.8 Liters
 Mixture Effect : Diesel + Chemical
 a) Fogging Effect : Water + Chemical
 b) Mist : Diesel + Chemical
 c) Semi Fog : Diesel + Chemical
 Chemical Tank Capacity : 400 cc
 Fuel Output : 2 Liters/hour
 (Made in Korea)

P925



Heavy Duty fogger BF-150

Type : Thermal Aerosol Fog
 Starting Method : Push Button Start
 Power Supply : 12V DC Rechargeable Battery
 Gasoline Tank Capacity : 1.8 Liters
 Gasoline Consumption : 1.5Liters/hour
 Solution Tank Capacity : 8 Liters
 Solution Output : 40Liters/hour
 Solution Tank Material : Stainless Steel

P926



Pro SMK 220
 Electric Insect Killer (Electrical Grille)

Size : 650 (W) x 105 (W) x 435 (H) mm
 Power Out Put : 20 watt (Tubular Tube) x 2tube
 Weight : 4kg
 Electrical Volts : 240V 50Hz 13A
 Action Range : 30 metres
 Material : Aluminium Casing
 SMK 220 Insect Killer (Electric Grille)

P927



Aerospace 30
 Wall Mounted / Free Standing
 Ideal for F&B outlets, hotels, dining rooms.

Material : Powder coated Mild Steel
 Brightness : 2 x 15 Watts UV Light
 Dimension : 510mm x 230mm x 110mm
 Coverage Area : 60m²
 Weight : 3.0KG
 Colour : White
 Glueboard Size : 430mm x 250 mm

P928



High Perform 45
 Wall Mounted
 Ideal for food production and preparation areas.

Material : Stainless steel Frontcover & Epoxy Steel Base
 Brightness : 3 x 15 Watts UV Light
 Dimension : 463mm x 300mm x 73mm
 Coverage Area : 70m²
 Weight : 5.1Kg
 Glueboard Size : 430mm x 250 mm or 450mm x 280mm
 HACCP Compliance Extremely Durable

P929



Econtrap 15
 Insect Trapper
 Wall Mounted
 Ideal for F&B outlets, hotels, dining rooms.

Material : Powder coated Mild Steel
 Brightness : 1 x 15 Watts UV Light
 Dimension : 810mm x 200mm x 300 Htmm
 Coverage Area : 50m²
 Weight : 3.8KG
 Colour : White
 Glueboard Size : 430mm x 250 mm HACCP Compliance Extremely Durable

P930



SUPERZAP 60+
 Electric Insect killer (Electrical Grille)

Colour : White
 Power Output : 120w (30w Tubular Lamp x 4)
 Step Up Current : 4000 Volts
 Electrical Voltage : 240v 50/60hz 13A
 Product Dimension : 665mm (L) x 160mm (W) x 450mm (H)
 Product Weight : 10.8kg
 Packaging Weight : 12.5kg

P931



Wave 30
 Insect Trapper

Chemical Lamp : 15 watt (Tubular Tube) x 2 tube
 Dimension : 550mm X 130mm X 125mm
 Type : Wall Mounted
 Ideal for F&B outlets, hotels, dining rooms.

Material : Powder coated Mild Steel
 Brightness : 2 x 15 Watts UV Light
 Coverage Area : 30m²
 Weight : 3.2 KG
 Colour : White , Black
 Glueboard Size : 430mm x 120 mm

P932



Glue Board
 Size: 120mm x 450mm (small)
 280mm x 450mm (Big)
 10 pcs/packet
 UV optimized glue board
 Heat & UV resistant and suitable in tropical climate.
 Printed grid on glue board enables users for fast counting of flies/caught.

P933



Radiance 30
 Insect Trapper
 Dimension : 505mm X 245mm X 95mm
 Type : Wall Mounted (Horizontal or Vertical)
 Ideal for F&B outlets, hotels, dining rooms.

Material : Powder coated Mild Steel
 Brightness : 2 x 15 Watts UV Light (Tubular Tube)
 Coverage Area : 30m²
 Weight : 3.6 KG
 Colour : White, Black
 Glueboard Size : 430mm x 120 mm

P934



Mosquito Tapper (High Performance)
 Brand : Violeeds
 4 time better Performance than traditional bulb based traps

Available Color : Black, White
 Power Consumption : 4W
 Attractant source : Optimized LEDs+ CO2 (365 nm UV LED wavelength)
 Dimension : 200 mm Dia x 232 mm Ht
 Weight : 3.59Kg
 Origin Country : Korea

P935



Hyper 30 (FL-803S) OZONE OUTPUT

Approximate : 3000 mg/hour
 Power : 60 watt
 Voltage : 220V / 50 Hz
 Size : 350 x 168 x 200 mm Ht
 Weight : 4.5kg
 Application : Portable
 304 Stainless Steel chassis with Build-In Blower & timer control

Quartz O3 Generator (DOUBLE LIFE SPAN than ordinary bulb generator)
 Features :
 - Bag room odor removal
 - Offices odor removal
 - Doctor and dentist offices odor removal
 - Home odor removal
 - Nursing home odor removal
 - Car odor removal
 - Fire restoration
 - Basements (mold/mildew, odors)
 - Kitchens
 - Kill airborne bacteria
 - Eliminate airborne pollen
 - Eliminate smoke and smoke odor immediately
 - Neutralize skunk and animal odors

- Product Features**
- Powerful UV light
 - Temperature optimized glue board
 - Hygienic solution to catch fly
 - Slim, silent, decorative and discreet flying insect trap
 - Good to have for restaurants, bakeries, food processing factories, canteen, cafeteria and food court
 - Factory warranty was given

Quality Affordable Lawn Care



Landscaping Machinery & Others

P936



NKT (Nakata) Backpack Blower
 Power Output : 2.1kW/2.86Hp
 Net Weight : 10.8kgs
 Displacement : 63.3cm³
 Mating Power : 1E48FP
 Dimension : 520 x 390 x 570mm

P937



EB 280
 NKT (Nakata) Handheld Blower
 Engine Type : 2 stroke, Air Cooled Single Cylinder
 Power Output : 0.84kW/1.12Hp
 Net Weight : 4.6kgs
 Displacement : 23.9cm³
 Average Air Volume (M3/S) : 0.17
 Fuel Tank : 0.6 Liter

P938



EB 260
 NKT (Nakata) Handheld Blower
 Engine Type : 2 stroke, Air Cooled Single Cylinder
 Power Output : 0.7kW/0.95Hp
 Net Weight : 5.5kgs
 Displacement : 25.4cm³
 Average Air Volume (M3/S) : 0.13
 Fuel Tank : 0.65 Liter

P939



TB 43
 NKT (Nakata) 430 Brush Cutter
 Mating Engine : 1E40F-5
 Discharging Capacity : 42.7cc
 Max Power : 1.25kW/6500rpm
 Type Of Carburetor : Float Type
 Start system : Easy Start

P940



Hedge Trimmer
 Motor : Kawasaki Engine TJ23V, 22.5 cm= Double blades, 750mm
 Max. blade opening 35 mm
 Cutting speed 1.32 m/s (9,000 r/min)
 Professional transmission
 Weight 5.4 kg
 180° rotatable handle with 5 positions

P941



Seladang 24" Lawnmower
 Engine : Robin Y20-3 5HP
 Fuel Tank Capacity : 3.8 Liter
 Cutting Width : 24"
 Blade Type : Haytex Blade
 Cutting Height & Position (mm) 25-80
 Front Wheel : 6" Dia, Rear Wheel : 7" Dia
 Packing Size (cm) : 92 x 58.5 x 46.5
 Weight : 37kg

P942



WL 35H-Manual
 Plunger Pump Petrol Engine Operated
 Pressure : 2.1-4.5MPa
 plunger number : 3
 Plunger Diameter : 30mm
 Power 2-3KW/ 5-6ps
 Output : 30-45 Liter/Min
 Weight : 12kgs (Pump Only)
 Engine : Honda 5HP

P943

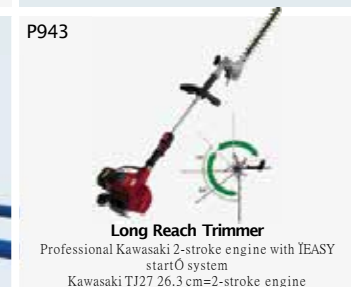

Long Reach Trimmer
 Professional Kawasaki 2-stroke engine with TEASY start O system
 Kawasaki TJ27 26.3 cm=2-stroke engine
 Double blades
 Length of blades : 525 mm
 Max. blade opening : 35 mm
 Shaft length 1.26m
 D-handle, Shaft Ø 24 mm
 Adjustable blade angle from - 488 to + 848
 Supplied with comfortable harness as standard
 Professional transmission and superhigh-quality blades
 Weight 6.3 kg

P944



HY 9000
 Chain Saw
 Brand : HYWAY
 Engine Type : Single Cylinder, Air forced, 2 Stroke.
 Rated Power : 2.3kW/8500
 Discharging Capacity : 60cc
 Bar length : 16", 18", 20", 22"
 Chain Pitch : 3/8"
 Fuel Tank Capacity : 550ml
 Oil Tank Capacity : 260ml
 Measurement : 420 x 255 x 260mm

P945



Portable Vatilation Fan
 Diameter : 300mm (12")
 Power : 520 W
 Voltage : 220V-240V, 50Hz
 Rotation Speed : 2800rpm
 Air Flow : 65cbm/Min
 Pressure : 370Pa
 Gross Weight : 12kgs

P946



Flexible Duct Hose
 Diameter : 300mm (12")
 Length : 5 meter
 Gross Weight : 5.5Kg

P947



VFAN26-S (Free Standing)
 Industrial Fan
 Power : 180 W
 voltage : 240V/50Hz
 Speed : 1400rpm
 Diameter : 26"

P948



VFAN18-S (Free Standing)
VFAN18-W (Wall Mounted)
 Industrial Fan
 Power : 100 W
 Voltage : 240V/50Hz
 Speed : 1350rpm
 Diameter : 18"

P949



Snow Wash Stainless Steel
 70 liters Tank
 Complete with Hose & Spray Nozzle

P950



SUD-001
 Wet Umbrella Sleeve Dispenser (Single Slot)
 Size: 320(L) x 210 (W) x 730(H)mm
 Maximum capacity : 1,000 long bags
 Prevents dangerous water accumulation on the floor

P951



Wet Umbrella Sleeve Stand
 28cm x 130cm (H)